

International  
**IOR** Rectifier

**QUIETIR** Series  
30EPF.. 30CPF..

## FAST SOFT RECOVERY RECTIFIER DIODE

### Description/Features

The 30EPF.. & 30CPF.. soft recovery **QUIETIR** rectifier series has been optimized for combined short reverse recovery time and low forward voltage drop.

The glass passivation ensures stable reliable operation in the most severe temperature and power cycling conditions.

Typical applications are:

- Output rectification and freewheeling in inverters, choppers and converters
- and input rectifications where severe restrictions on conducted EMI should be met.
- 30CPF series is a drop in replacement for 25CPF Series (parallel connection only)

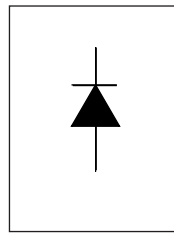

$$V_F < 1.2V @ 10A$$

$$t_{rr} = 60ns$$

$$V_{RRM} 200 \text{ to } 600V$$

### Major Ratings and Characteristics

Characteristics	30EPF.. 30CPF..	Units
$I_{F(AV)}$ Sinusoidal waveform	30	A
$V_{RRM}$	200 to 600	V
$I_{FSM}$	350	A
$V_F$ @ 10A, $T_J=25^\circ\text{C}$	1.2	V
$t_{rr}$ @ 1A, 100A/ $\mu\text{s}$	60	ns
$T_J$	-40 to 150	$^\circ\text{C}$

### Package Outline

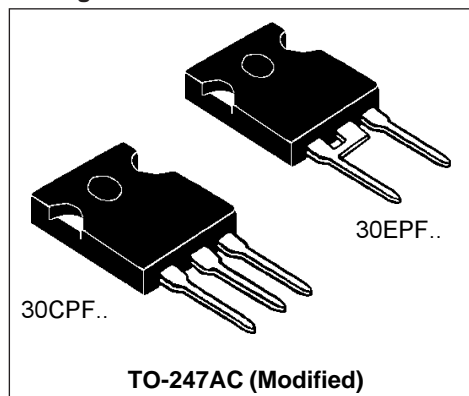

Voltage Ratings

Part Number	$V_{RRM}$ , maximum peak reverse voltage V	$V_{RSM}$ , maximum non repetitive peak reverse voltage V	$I_{RRM}$ 150°C mA
30EPF02, 30CPF02	200	300	2
30EPF04, 30CPF04	400	500	
30EPF06, 30CPF06	600	700	

Absolute Maximum Ratings

Parameters	30.PF..	Units	Conditions
$I_{F(AV)}$ Max. Average Forward Current	30	A	@ $T_c = 98^\circ\text{C}$ , 180° conduction half sine wave
$I_{FSM}$ Max. Peak One Cycle Non-Repetitive Surge Current	300	A	10ms Sine pulse, rated $V_{RRM}$ applied
	350		10ms Sine pulse, no voltage reapplied
$I^2t$ Max. $I^2t$ for fusing	450	$A^2s$	10ms Sine pulse, rated $V_{RRM}$ applied
	636		10ms Sine pulse, no voltage reapplied
$I^2\sqrt{t}$ Max. $I^2\sqrt{t}$ for fusing	6360	$A^2\sqrt{s}$	$t = 0.1$ to 10ms, no voltage reapplied

Electrical Specifications

Parameters	30.PF..	Units	Conditions
$V_{FM}$ Max. Forward Voltage Drop	1.41	V	@ 30A, $T_J = 25^\circ\text{C}$
$r_t$ Forward slope resistance	12.5	$m\Omega$	$T_J = 150^\circ\text{C}$
$V_{F(TO)}$ Threshold voltage	0.9	V	
$I_{RM}$ Max. Reverse Leakage Current	0.1	mA	$T_J = 25^\circ\text{C}$
	2.0		$T_J = 150^\circ\text{C}$

$V_R = \text{rated } V_{RRM}$

Typical Recovery Characteristics

Parameters	30.PF..	Units	Conditions
$t_{rr}$ Reverse Recovery Time	160	ns	$I_F @ 20\text{Apk}$ @ 100A/ $\mu\text{s}$ @ 25°C
$I_{rr}$ Reverse Recovery Current	10	A	
$Q_{rr}$ Reverse Recovery Charge	1.25	$\mu\text{C}$	
S Snap Factor $t_b/t_a$	0.6	typical	

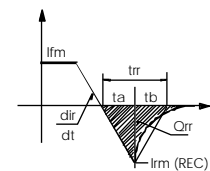

Thermal-Mechanical Specifications

Parameters	30.PF..	Units	Conditions
$T_J$ Max. Junction Temperature Range	-40 to 150	°C	
$T_{stg}$ Max. Storage Temperature Range	-40 to 150	°C	
$R_{thJC}$ Max. Thermal Resistance Junction to Case	0.8	°C/W	DC operation
$R_{thJA}$ Max. Thermal Resistance Junction to Ambient	40	°C/W	
$R_{thCS}$ Typical Thermal Resistance, Case to Heatsink	0.2	°C/W	Mounting surface , smooth and greased
wt Approximate Weight	6 (0.21)	g (oz.)	
T Mounting Torque	Min.	6 (5)	Kg-cm (lbf-in)
	Max.	12 (10)	
Case Style	TO-247AC		JEDEC (Modified)

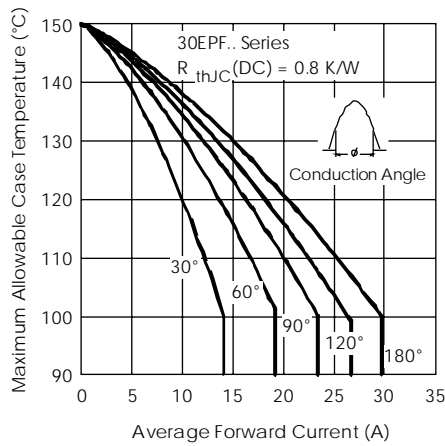

Fig. 1 - Current Rating Characteristics

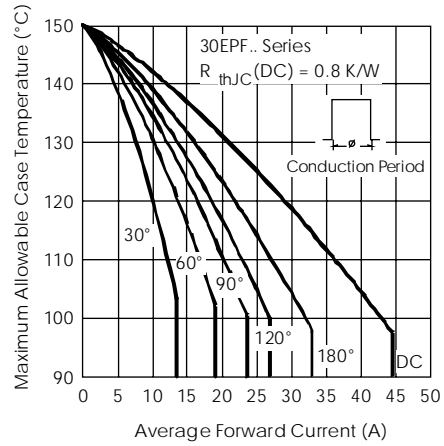

Fig. 2 - Current Rating Characteristics

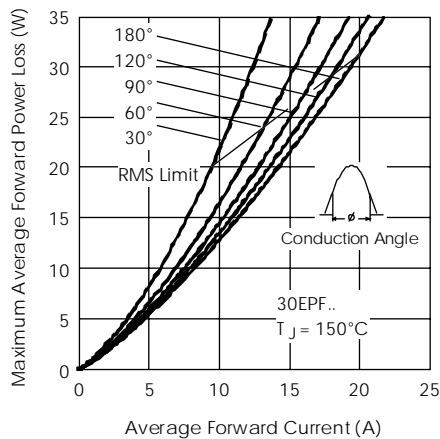

Fig. 3 - Forward Power Loss Characteristics

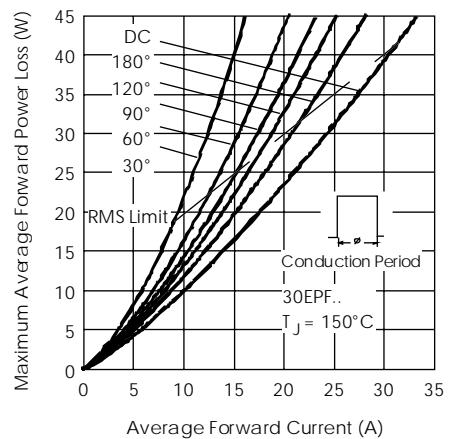

Fig. 4 - Forward Power Loss Characteristics

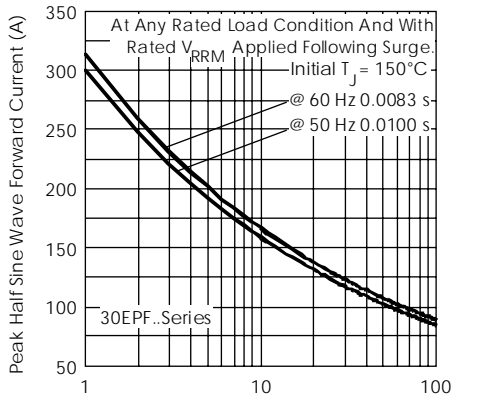

Fig. 5 - Maximum Non-Repetitive Surge Current

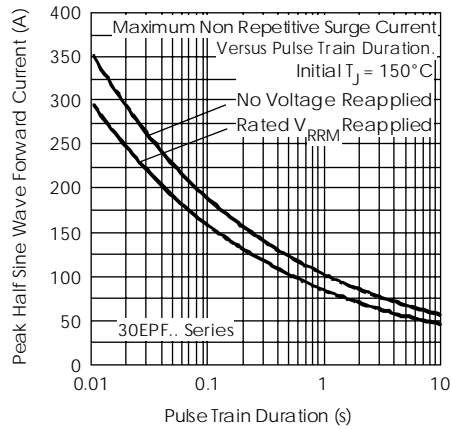

Fig. 6 - Maximum Non-Repetitive Surge Current

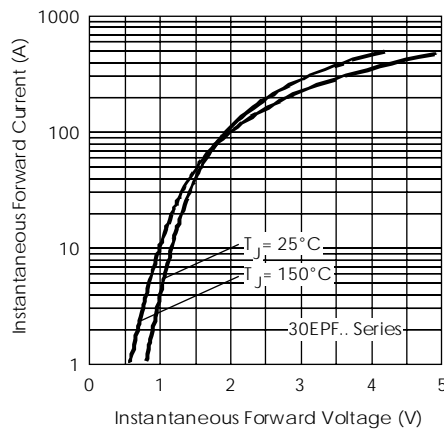

Fig. 7 - Forward Voltage Drop Characteristics

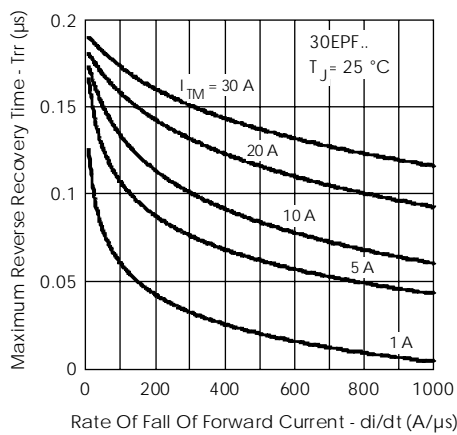

Fig. 8 - Recovery Time Characteristics,  $T_J = 25^\circ\text{C}$

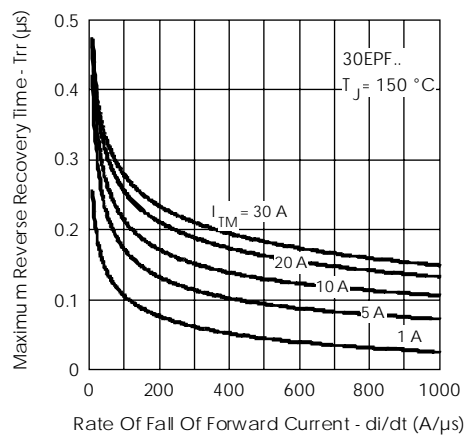

Fig. 9 - Recovery Time Characteristics,  $T_J = 150^\circ\text{C}$

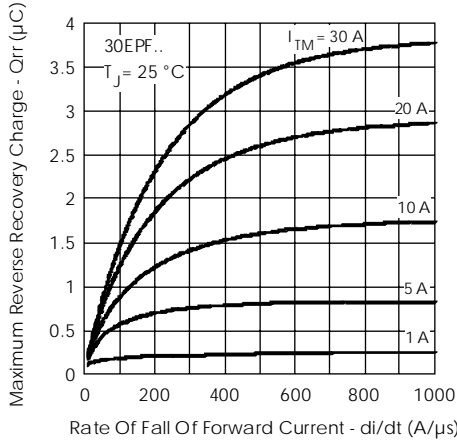

Fig. 10 - Recovery Charge Characteristics,  $T_J = 25^\circ\text{C}$

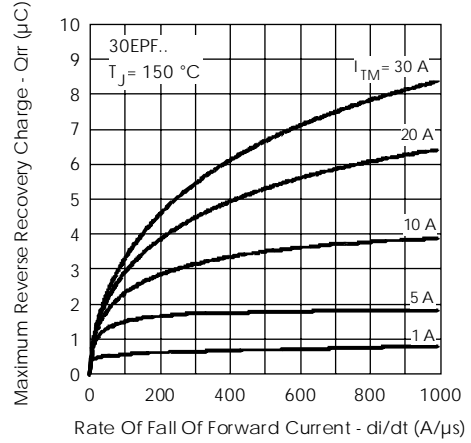

Fig. 11 - Recovery Charge Characteristics,  $T_J = 150^\circ\text{C}$

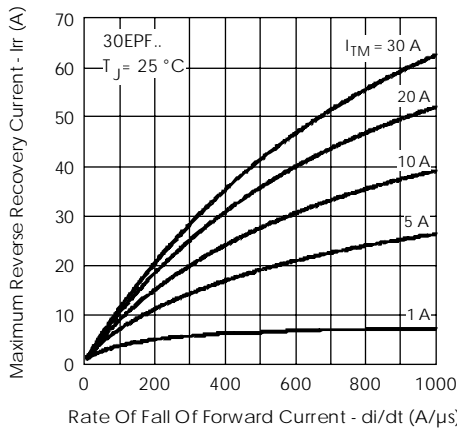

Fig. 12 - Recovery Current Characteristics,  $T_J = 25^\circ\text{C}$

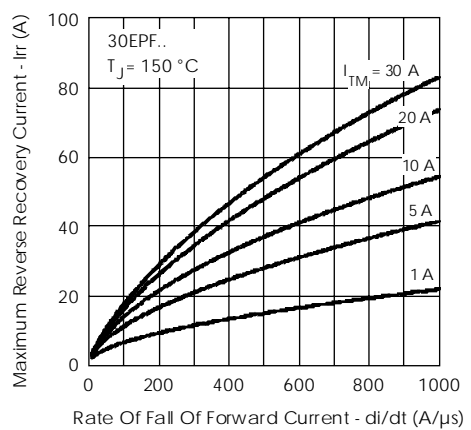

Fig. 13 - Recovery Current Characteristics,  $T_J = 150^\circ\text{C}$

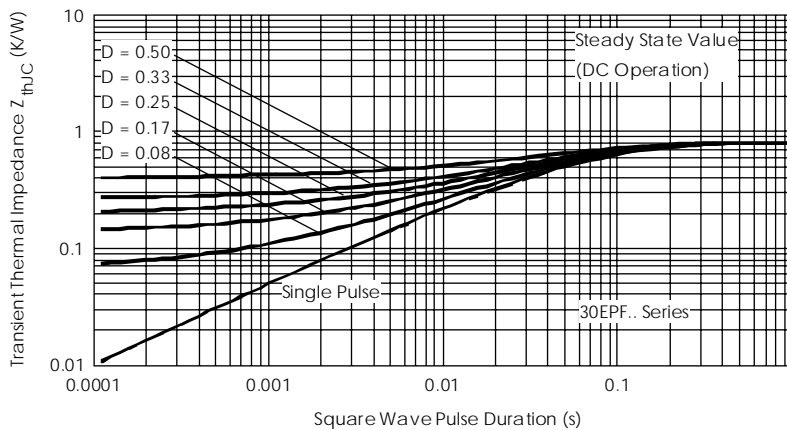
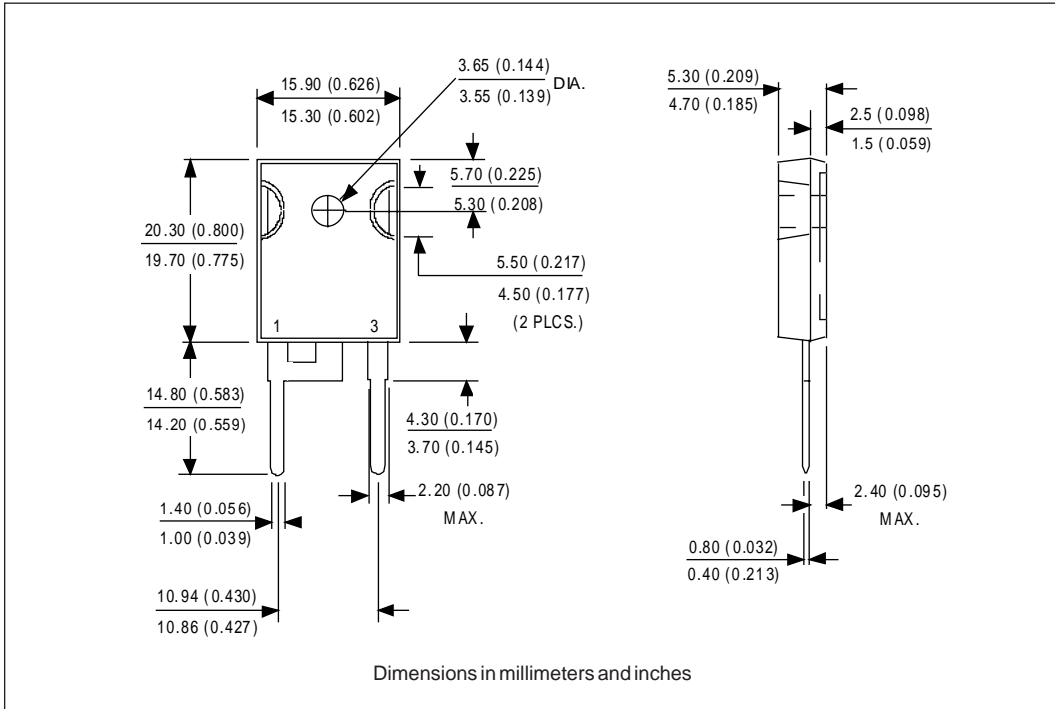
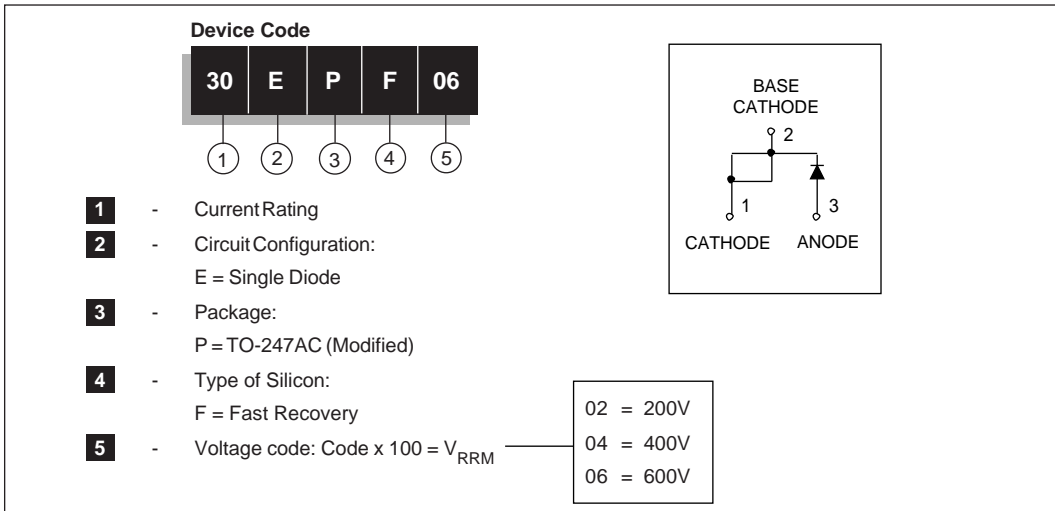

Fig. 14 - Thermal Impedance  $Z_{thJC}$  Characteristics

Outline Table



Ordering Information Table



Outline Table

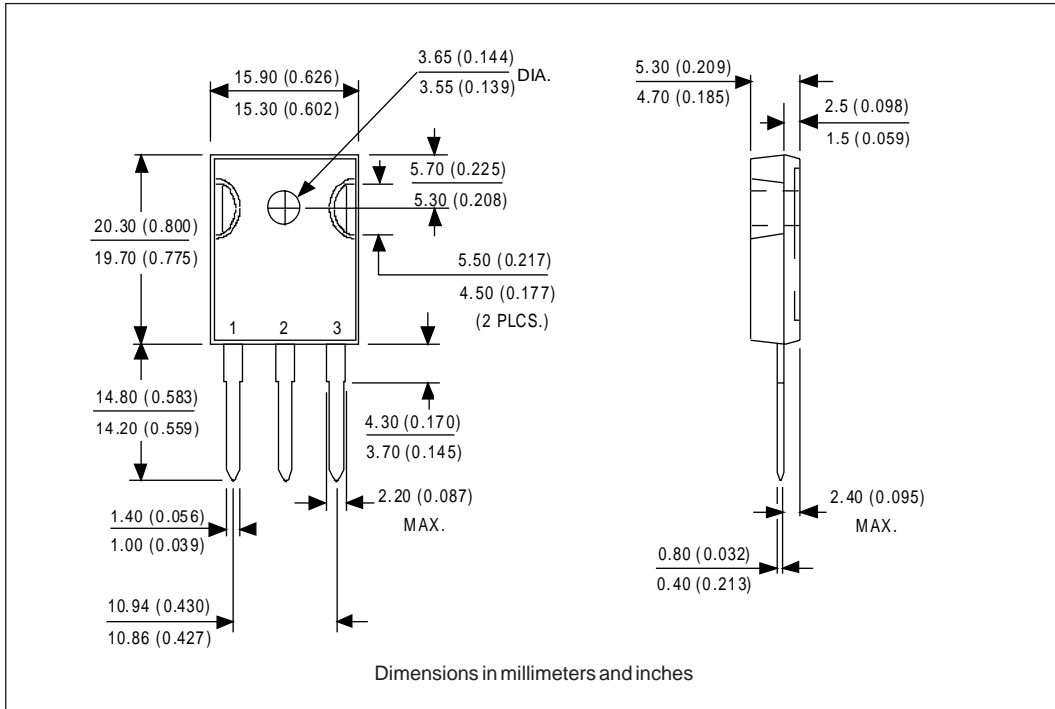

Ordering Information Table

