

Small Signal Zener Diodes

Features

- These diodes are also available in other case styles and other configurations including: the SOD-123 case with type designation BZT52 series, the dual zener diode common anode configuration in the SOT-23 case with type designation AZ23 series and the dual zener diode common cathode configuration in the SOT-23 case with type designation DZ23 series.
- The Zener voltages are graded according to the international E 24 standard. Standard Zener voltage tolerance is $\pm 5\%$. Replace "C" with "B" for $\pm 2\%$ tolerance.
- Silicon Planar Power Zener Diodes
- Lead (Pb)-free component
- Component in accordance to RoHS 2002/95/EC and WEEE 2002/96/EC

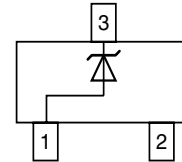
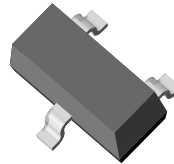

18078

Mechanical Data

Case: SOT-23 Plastic case

Weight: approx. 8.8 mg

Packaging Codes/Options:

GS18 / 10 k per 13" reel (8 mm tape), 10 k/box

GS08 / 3 k per 7" reel (8 mm tape), 15 k/box

Absolute Maximum Ratings

$T_{amb} = 25\text{ }^{\circ}\text{C}$, unless otherwise specified

Parameter	Test condition	Symbol	Value	Unit
Power dissipation		P_{tot}	300 ¹⁾	mW

¹⁾ Device on fiberglass substrate, see layout.

Thermal Characteristics

$T_{amb} = 25\text{ }^{\circ}\text{C}$, unless otherwise specified

Parameter	Test condition	Symbol	Value	Unit
Thermal resistance junction to ambient air		R_{thJA}	420 ¹⁾	$^{\circ}\text{C}/\text{W}$
Junction temperature		T_j	150	$^{\circ}\text{C}$
Storage temperature range		T_s	- 65 to + 150	$^{\circ}\text{C}$

¹⁾ Device on fiberglass substrate, see layout.

Electrical Characteristics

Partnumber	Marking Code	Zener Voltage Range		Dynamic Resistance		Test Current	Temp. Coefficient of Zener Voltage		Test Current	Reverse Leakage Current			
		$V_Z @ I_{ZT1}$		$r_{zj} @ I_{ZT1}$	$r_{zj} @ I_{ZT2}$		I_{ZT1}	$\alpha_{VZ} @ I_{ZT1}$		I_{ZT2}	I_R	@ V_R	
		V		Ω			mA	$10^{-4}/^{\circ}C$		mA	μA	V	
		min	max				min	max					
BZX84C2V4-V	Z11	2.2	2.6	70 (≤ 100)	275	5	-9.0	-4.0	1	50	1		
BZX84C2V7-V	Z12	2.5	2.9	75 (≤ 100)	300 (≤ 600)	5	-9.0	-4.0	1	20	1		
BZX84C3V0-V	Z13	2.8	3.2	80 (≤ 95)	325 (≤ 600)	5	-9.0	-3.0	1	10	1		
BZX84C3V3-V	Z14	3.1	3.5	85 (≤ 95)	350 (≤ 600)	5	-8.0	-3.0	1	5	1		
BZX84C3V6-V	Z15	3.4	3.8	85 (≤ 90)	375 (≤ 600)	5	-8.0	-3.0	1	5	1		
BZX84C3V9-V	Z16	3.7	4.1	85 (≤ 90)	400 (≤ 600)	5	-7.0	-3.0	1	3	1		
BZX84C4V3-V	Z17	4	4.6	80 (≤ 90)	410 (≤ 600)	5	-6.0	-1.0	1	3	1		
BZX84C4V7-V	Z1	4.4	5	50 (≤ 80)	425 (≤ 500)	5	-5.0	+2.0	1	3	2		
BZX84C5V1-V	Z2	4.8	5.4	40 (≤ 60)	400 (≤ 480)	5	-3.0	+4.0	1	2	2		
BZX84C5V6-V	Z3	5.2	6	15 (≤ 40)	80 (≤ 400)	5	-2.0	+6.0	1	1	2		
BZX84C6V2-V	Z4	5.8	6.6	6.0 (≤ 10)	40 (≤ 150)	5	-1.0	+7.0	1	3	4		
BZX84C6V8-V	Z5	6.4	7.2	6.0 (≤ 15)	30 (≤ 80)	5	+2.0	+7.0	1	2	4		
BZX84C7V5-V	Z6	7	7.9	6.0 (≤ 15)	30 (≤ 80)	5	+3.0	+7.0	1	1	5		
BZX84C8V2-V	Z7	7.7	8.7	6.0 (≤ 15)	40 (≤ 80)	5	+4.0	+7.0	1	0.7	5		
BZX84C9V1-V	Z8	8.5	9.6	6.0 (≤ 15)	40 (≤ 100)	5	+5.0	+8.0	1	0.5	6		
BZX84C10-V	Z9	9.4	10.6	8.0 (≤ 20)	50 (≤ 150)	5	+5.0	+8.0	1	0.2	7		
BZX84C11-V	Y1	10.4	11.6	10 (≤ 20)	50 (≤ 150)	5	+5.0	+9.0	1	0.1	8		
BZX84C12-V	Y2	11.4	12.7	10 (≤ 25)	50 (≤ 150)	5	+6.0	+9.0	1	0.1	8		
BZX84C13-V	Y3	12.4	14.1	10 (≤ 30)	50 (≤ 170)	5	+7.0	+9.0	1	0.1	8		
BZX84C15-V	Y4	13.8	15.6	10 (≤ 30)	50 (≤ 200)	5	+7.0	+9.0	1	0.05	0.7 V_{Znom} .		
BZX84C16-V	Y5	15.3	17.1	10 (≤ 40)	50 (≤ 200)	5	+8.0	+9.5	1	0.05	0.7 V_{Znom} .		
BZX84C18-V	Y6	16.8	19.1	10 (≤ 45)	50 (≤ 225)	5	+8.0	+9.5	1	0.05	0.7 V_{Znom} .		
BZX84C20-V	Y7	18.8	21.2	15 (≤ 55)	60 (≤ 225)	5	+8.0	+10	1	0.05	0.7 V_{Znom} .		
BZX84C22-V	Y8	20.8	23.3	20 (≤ 55)	60 (≤ 250)	5	+8.0	+10	1	0.05	0.7 V_{Znom} .		
BZX84C24-V	Y9	22.8	25.6	25 (≤ 70)	60 (≤ 250)	5	+8.0	+10	1	0.05	0.7 V_{Znom} .		
BZX84C27-V	Y10	25.1	28.9	25 (≤ 80)	65 (≤ 300)	2	+8.0	+10	0.5	0.05	0.7 V_{Znom} .		
BZX84C30-V	Y11	28	32	30 (≤ 80)	70 (≤ 300)	2	+8.0	+10	0.5	0.05	0.7 V_{Znom} .		
BZX84C33-V	Y12	31	35	35 (≤ 80)	75 (≤ 325)	2	+8.0	+10	0.5	0.05	0.7 V_{Znom} .		
BZX84C36-V	Y13	34	38	35 (≤ 90)	80 (≤ 350)	2	+8.0	+10	0.5	0.05	0.7 V_{Znom} .		
BZX84C39-V	Y14	37	41	40 (≤ 130)	80 (≤ 350)	2	+10	+12	0.5	0.05	0.7 V_{Znom} .		
BZX84C43-V	Y15	40	46	45 (≤ 150)	85 (≤ 375)	2	+10	+12	0.5	0.05	0.7 V_{Znom} .		
BZX84C47-V	Y16	44	50	50 (≤ 170)	85 (≤ 375)	2	+10	+12	0.5	0.05	0.7 V_{Znom} .		
BZX84C51-V	Y17	48	54	60 (≤ 180)	85 (≤ 400)	2	+10	+12	0.5	0.05	0.7 V_{Znom} .		
BZX84C56-V	Y18	52	60	70 (≤ 200)	100 (≤ 425)	2	+9.0	+11	0.5	0.05	0.7 V_{Znom} .		
BZX84C62-V	Y19	58	66	80 (≤ 215)	100 (≤ 450)	2	+9.0	+12	0.5	0.05	0.7 V_{Znom} .		
BZX84C68-V	Y20	64	72	90 (≤ 240)	150 (≤ 475)	2	+10	+12	0.5	0.05	0.7 V_{Znom} .		
BZX84C75-V	Y21	70	79	95 (≤ 255)	170 (≤ 500)	2	+10	+12	0.5	0.05	0.7 V_{Znom} .		



Electrical Characteristics

Partnumber	Marking Code	Zener Voltage Range		Dynamic Resistance		Test Current	Temp. Coefficient of Zener Voltage		Test Current	Reverse Leakage Current	
		$V_Z @ I_{ZT1}$		$r_{zj} @ I_{ZT1}$	$r_{zj} @ I_{ZT2}$		I_{ZT1}	$\alpha_{VZ} @ I_{ZT1}$		I_{ZT2}	I_R
		V		Ω		mA	$10^{-4}/^{\circ}\text{C}$		mA	μA	V
		min	max				min	max			
BZX84B2V4-V	Z50	2.35	2.45	70 (≤ 100)	275	5	-9	-4	1	50	1
BZX84B2V7-V	Z51	2.65	2.75	75 (≤ 100)	300 (≤ 600)	5	-9	-4	1	20	1
BZX84B3V0-V	Z52	2.94	3.06	80 (≤ 95)	325 (≤ 600)	5	-9	-3	1	10	1
BZX84B3V3-V	Z53	3.23	3.37	85 (≤ 95)	350 (≤ 600)	5	-8	-3	1	5	1
BZX84B3V6-V	Z54	3.53	3.67	85 (≤ 90)	375 (≤ 600)	5	-8	-3	1	5	1
BZX84B3V9-V	Z55	3.82	3.98	85 (≤ 90)	400 (≤ 600)	5	-7	-3	1	3	1
BZX84B4V3-V	Z56	4.21	4.39	80 (≤ 90)	410 (≤ 600)	5	-6	-1	1	3	1
BZX84B4V7-V	Z57	4.61	4.79	50 (≤ 80)	425 (≤ 500)	5	-5	2	1	3	2
BZX84B5V1-V	Z58	5	5.2	40 (≤ 60)	400 (≤ 480)	5	-3	4	1	2	2
BZX84B5V6-V	Z59	5.49	5.71	15 (≤ 40)	80 (≤ 400)	5	-2	6	1	1	2
BZX84B6V2-V	Z60	6.08	6.32	6.0 (≤ 10)	40 (≤ 150)	5	-1	7	1	3	4
BZX84B6V8-V	Z61	6.66	6.94	6.0 (≤ 15)	30 (≤ 80)	5	2	7	1	2	4
BZX84B7V5-V	Z62	7.35	7.65	6.0 (≤ 15)	30 (≤ 80)	5	3	7	1	1	5
BZX84B8V2-V	Z63	8.04	8.36	6.0 (≤ 15)	40 (≤ 80)	5	4	7	1	0.7	5
BZX84B9V1-V	Z64	8.92	9.28	6.0 (≤ 15)	40 (≤ 100)	5	5	8	1	0.5	6
BZX84B10-V	Z65	9.8	10.2	8.0 (≤ 20)	50 (≤ 150)	5	5	8	1	0.2	7
BZX84B11-V	Z66	10.8	11.2	10 (≤ 20)	50 (≤ 150)	5	5	9	1	0.1	8
BZX84B12-V	Z67	11.8	12.2	10 (≤ 25)	50 (≤ 150)	5	6	9	1	0.1	8
BZX84B13-V	Z68	12.7	13.3	10 (≤ 30)	50 (≤ 170)	5	7	9	1	0.1	8
BZX84B15-V	Z69	14.7	15.3	10 (≤ 30)	50 (≤ 200)	5	7	9	1	0.05	0.7 $V_{Znom.}$
BZX84B16-V	Z70	15.7	16.3	10 (≤ 40)	50 (≤ 200)	5	8	9.5	1	0.05	0.7 $V_{Znom.}$
BZX84B18-V	Z71	17.6	18.4	10 (≤ 45)	50 (≤ 225)	5	8	9.5	1	0.05	0.7 $V_{Znom.}$
BZX84B20-V	Z72	19.6	20.4	15 (≤ 55)	60 (≤ 225)	5	8	10	1	0.05	0.7 $V_{Znom.}$
BZX84B22-V	Z73	21.6	22.4	20 (≤ 55)	60 (≤ 250)	5	8	10	1	0.05	0.7 $V_{Znom.}$
BZX84B24-V	Z74	23.5	24.5	25 (≤ 70)	60 (≤ 250)	5	8	10	1	0.05	0.7 $V_{Znom.}$
BZX84B27-V	Z75	26.5	27.5	25 (≤ 80)	65 (≤ 300)	2	8	10	0.5	0.05	0.7 $V_{Znom.}$
BZX84B30-V	Z76	29.4	30.6	30 (≤ 80)	70 (≤ 300)	2	8	10	0.5	0.05	0.7 $V_{Znom.}$
BZX84B33-V	Z77	32.3	33.7	35 (≤ 80)	75 (≤ 325)	2	8	10	0.5	0.05	0.7 $V_{Znom.}$
BZX84B36-V	Z78	35.3	36.7	35 (≤ 90)	80 (≤ 350)	2	8	10	0.5	0.05	0.7 $V_{Znom.}$
BZX84B39-V	Z79	38.2	39.8	40 (≤ 130)	80 (≤ 350)	2	10	12	0.5	0.05	0.7 $V_{Znom.}$
BZX84B43-V	Z80	42.1	43.9	45 (≤ 150)	85 (≤ 375)	2	10	12	0.5	0.05	0.7 $V_{Znom.}$
BZX84B47-V	Z81	46.1	47.9	50 (≤ 170)	85 (≤ 375)	2	10	12	0.5	0.05	0.7 $V_{Znom.}$
BZX84B51-V	Z82	50	52	60 (≤ 180)	85 (≤ 400)	2	10	12	0.5	0.05	0.7 $V_{Znom.}$
BZX84B56-V	Z83	54.9	57.1	70 (≤ 200)	100 (≤ 425)	2	9	11	0.5	0.05	0.7 $V_{Znom.}$
BZX84B62-V	Z84	60.8	63.2	80 (≤ 215)	100 (≤ 450)	2	9	12	0.5	0.05	0.7 $V_{Znom.}$
BZX84B68-V	Z85	66.6	69.4	90 (≤ 240)	150 (≤ 475)	2	10	12	0.5	0.05	0.7 $V_{Znom.}$
BZX84B75-V	Z86	73.5	76.5	95 (≤ 255)	170 (≤ 500)	2	10	12	0.5	0.05	0.7 $V_{Znom.}$

Typical Characteristics (Tamb = 25 °C unless otherwise specified)

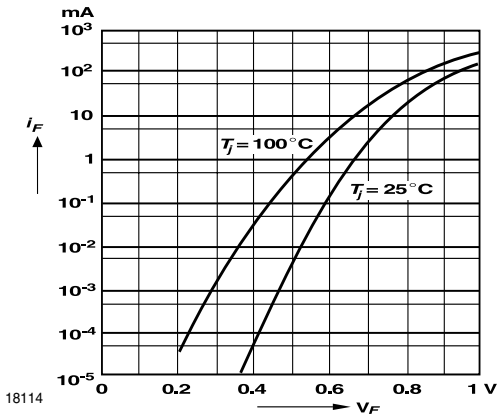

Figure 1. Forward characteristics

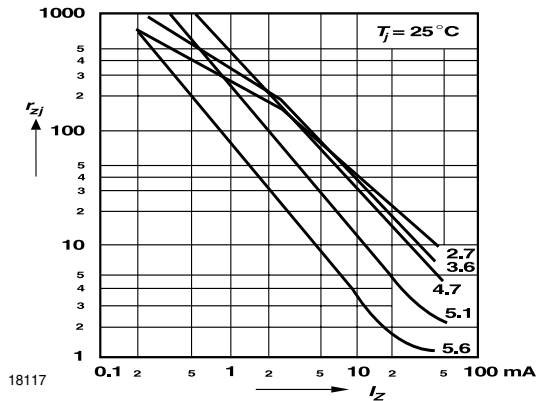

Figure 4. Dynamic Resistance vs. Zener Current

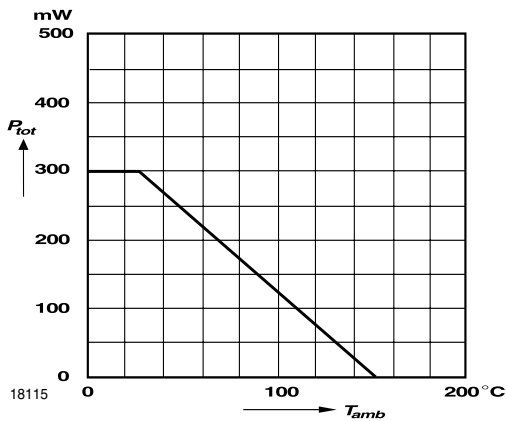

Figure 2. Admissible Power Dissipation vs. Ambient Temperature

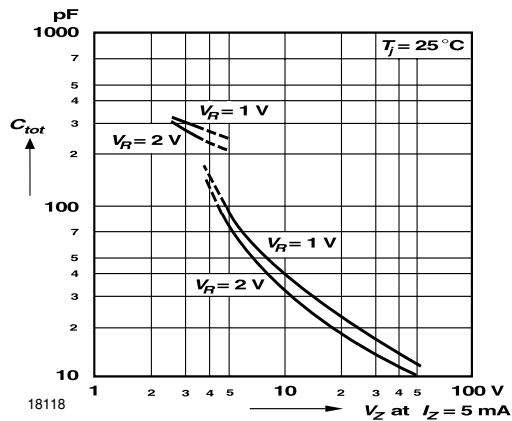

Figure 5. Capacitance vs. Zener Voltage

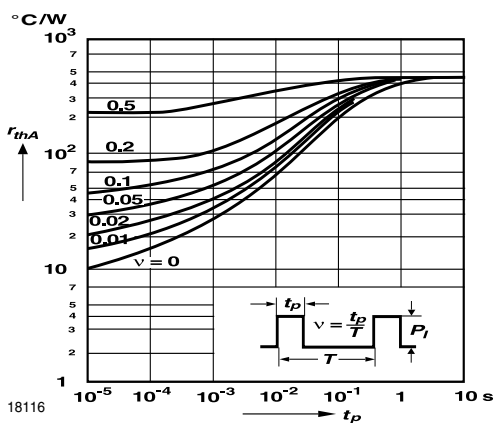

Figure 3. Pulse Thermal Resistance vs. Pulse Duration

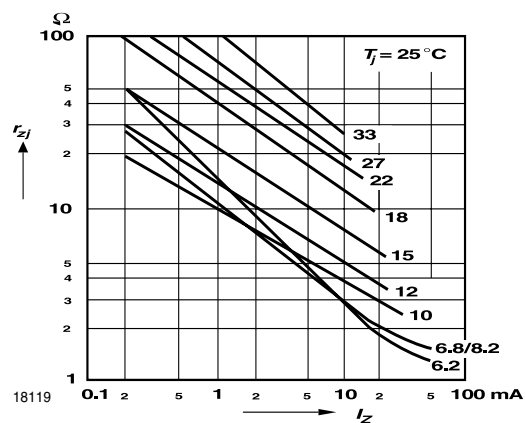

Figure 6. Dynamic Resistance vs. Zener Current

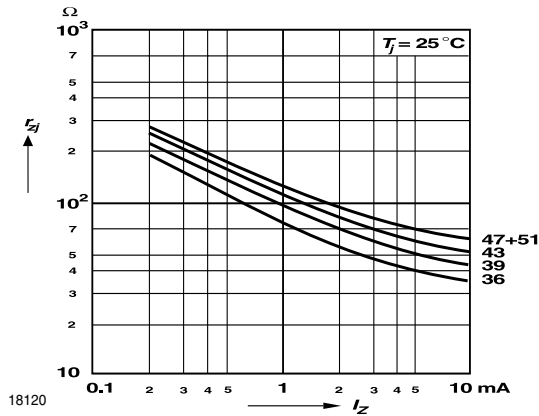

Figure 7. Dynamic Resistance vs. Zener Current

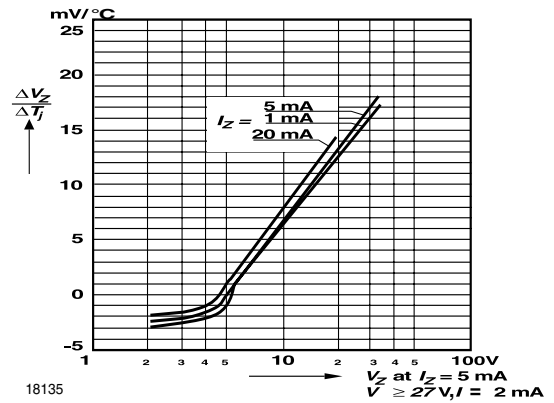

Figure 10. Temperature Dependence of Zener Voltage vs. Zener Voltage

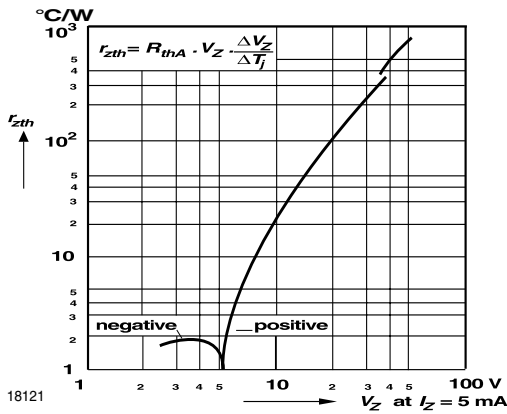

Figure 8. Thermal Differential Resistance vs. Zener Voltage

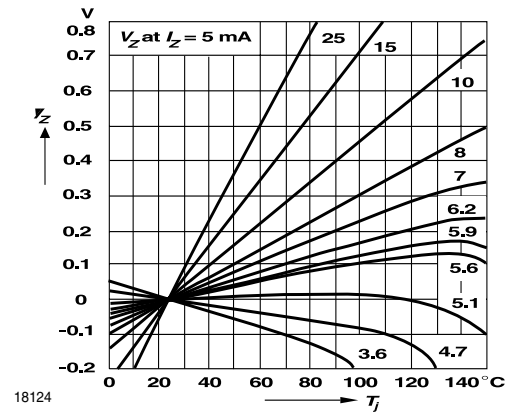

Figure 11. Change of Zener Voltage vs. Junction Temperature

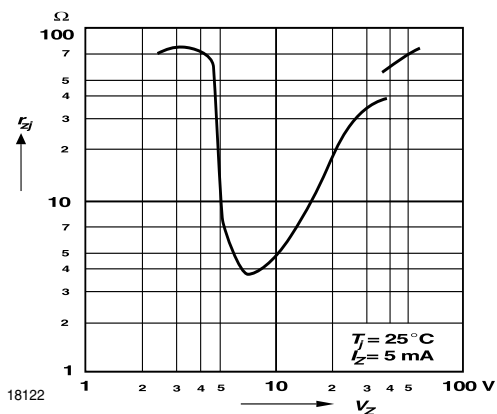

Figure 9. Dynamic Resistance vs. Zener Voltage

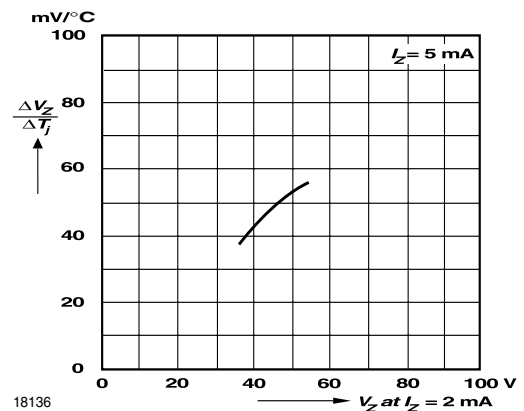

Figure 12. Temperature Dependence of Zener Voltage vs. Zener Voltage

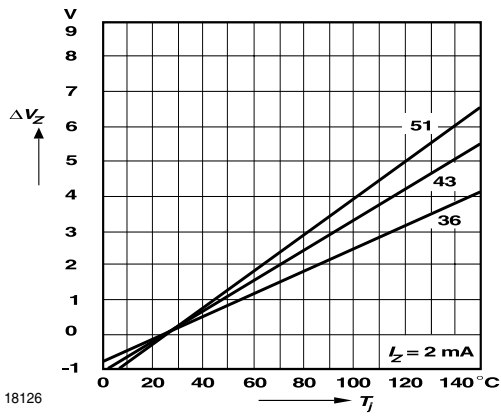

Figure 13. Change of Zener Voltage vs. Junction Temperature

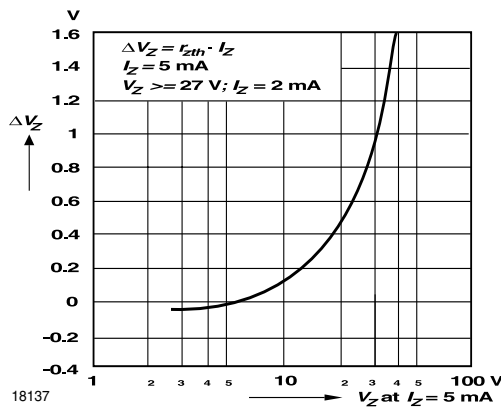

Figure 14. Change of Zener voltage from turn-on up to the point of thermal equilibrium vs. Zener voltage

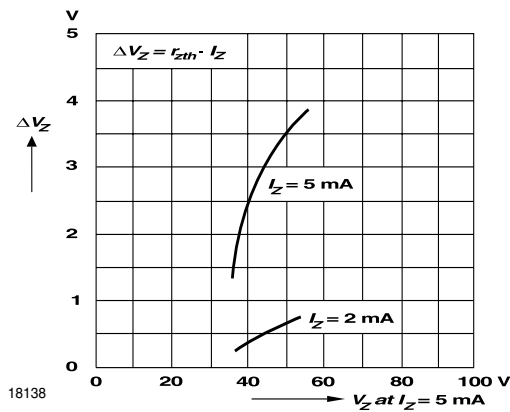

Figure 15. Change of Zener voltage from turn-on up to the point of thermal equilibrium vs. Zener voltage

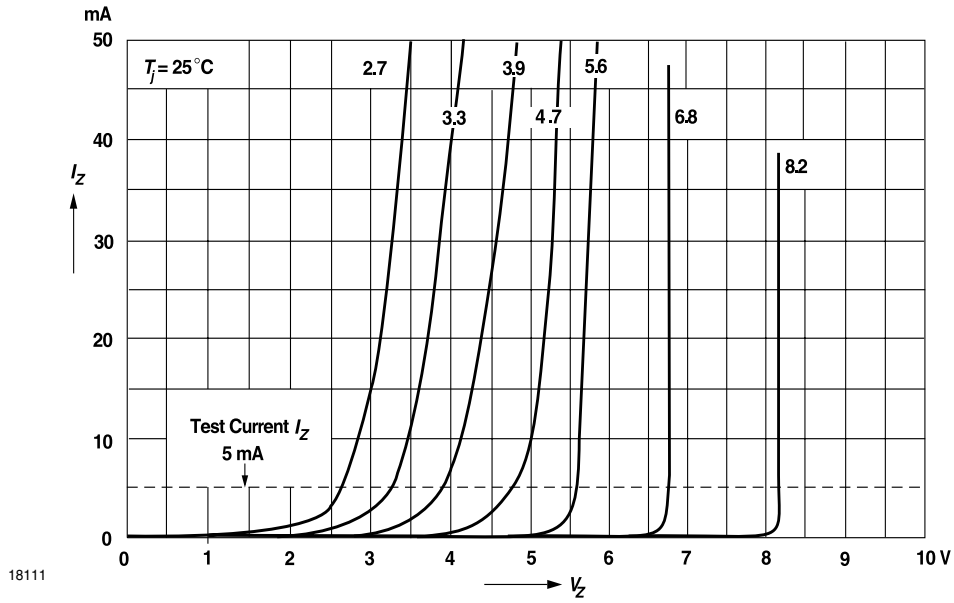

Figure 16. Breakdown Characteristics

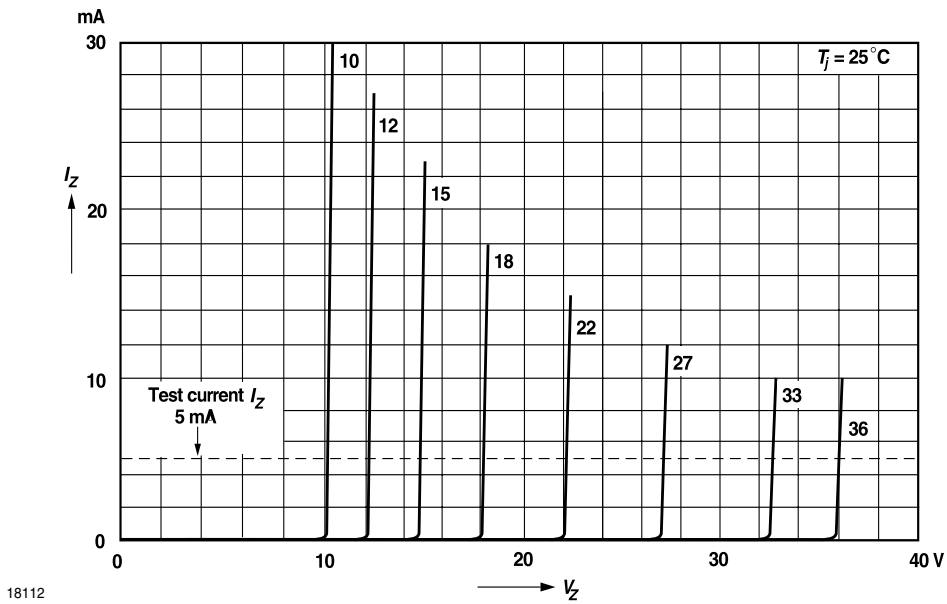
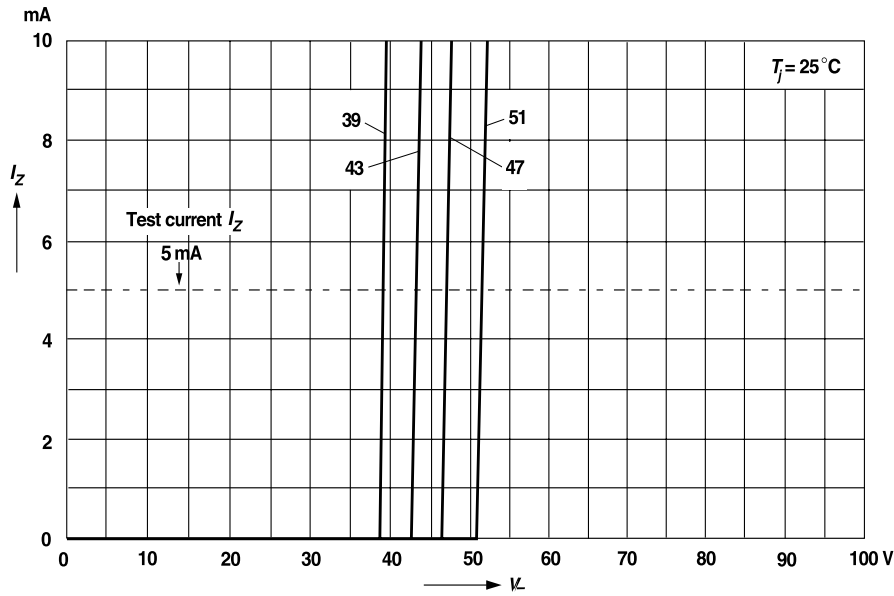

Figure 17. Breakdown Characteristics



18113

Figure 18. Breakdown Characteristics

Layout for $R_{\text{Theta};\text{JA}}$ test

Thickness: Fiberglass 0.059 in. (1.5 mm)

Copper leads 0.012 in. (0.3 mm)

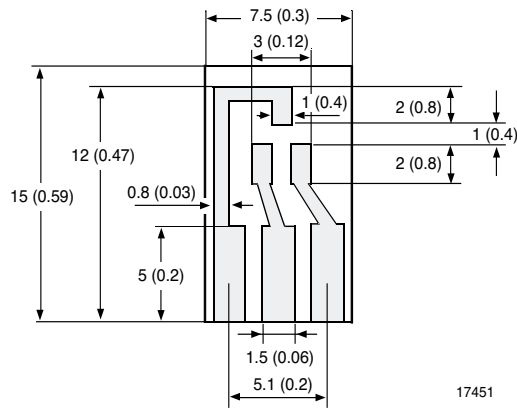

17451

Package Dimensions in mm (Inches)

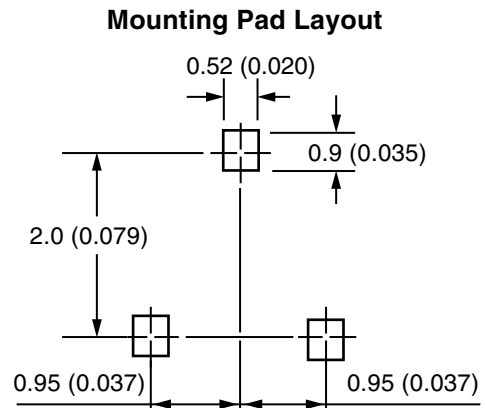
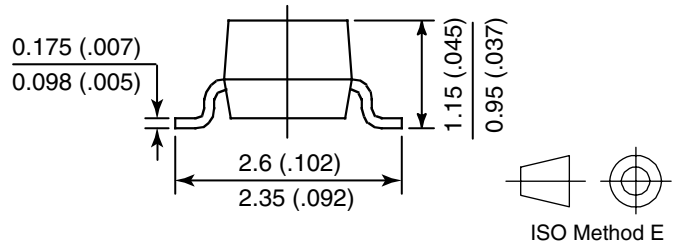
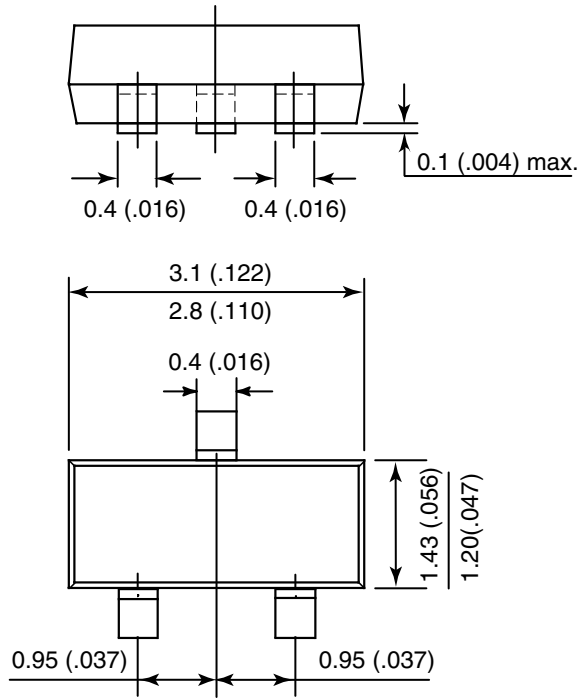

17418

Ozone Depleting Substances Policy Statement

It is the policy of Vishay Semiconductor GmbH to

1. Meet all present and future national and international statutory requirements.
2. Regularly and continuously improve the performance of our products, processes, distribution and operating systems with respect to their impact on the health and safety of our employees and the public, as well as their impact on the environment.

It is particular concern to control or eliminate releases of those substances into the atmosphere which are known as ozone depleting substances (ODSs).

The Montreal Protocol (1987) and its London Amendments (1990) intend to severely restrict the use of ODSs and forbid their use within the next ten years. Various national and international initiatives are pressing for an earlier ban on these substances.

Vishay Semiconductor GmbH has been able to use its policy of continuous improvements to eliminate the use of ODSs listed in the following documents.

1. Annex A, B and list of transitional substances of the Montreal Protocol and the London Amendments respectively
2. Class I and II ozone depleting substances in the Clean Air Act Amendments of 1990 by the Environmental Protection Agency (EPA) in the USA
3. Council Decision 88/540/EEC and 91/690/EEC Annex A, B and C (transitional substances) respectively.

Vishay Semiconductor GmbH can certify that our semiconductors are not manufactured with ozone depleting substances and do not contain such substances.

We reserve the right to make changes to improve technical design
and may do so without further notice.

Parameters can vary in different applications. All operating parameters must be validated for each customer application by the customer. Should the buyer use Vishay Semiconductors products for any unintended or unauthorized application, the buyer shall indemnify Vishay Semiconductors against all claims, costs, damages, and expenses, arising out of, directly or indirectly, any claim of personal damage, injury or death associated with such unintended or unauthorized use.

Vishay Semiconductor GmbH, P.O.B. 3535, D-74025 Heilbronn, Germany



Notice

Specifications of the products displayed herein are subject to change without notice. Vishay Intertechnology, Inc., or anyone on its behalf, assumes no responsibility or liability for any errors or inaccuracies.

Information contained herein is intended to provide a product description only. No license, express or implied, by estoppel or otherwise, to any intellectual property rights is granted by this document. Except as provided in Vishay's terms and conditions of sale for such products, Vishay assumes no liability whatsoever, and disclaims any express or implied warranty, relating to sale and/or use of Vishay products including liability or warranties relating to fitness for a particular purpose, merchantability, or infringement of any patent, copyright, or other intellectual property right.

The products shown herein are not designed for use in medical, life-saving, or life-sustaining applications. Customers using or selling these products for use in such applications do so at their own risk and agree to fully indemnify Vishay for any damages resulting from such improper use or sale.

www.s-manuals.com