

High and Low Side Driver

Features

- Floating channel designed for bootstrap operation
- Fully operational to +1200 V
- Tolerant to negative transient voltage
- dV/dt immune
- Gate drive supply range from 12 V to 20 V
- Undervoltage lockout for both channels
- 3.3 V logic compatible
- Separate logic supply range from 3.3 V to 20 V
- Logic and power ground ± 5 V offset
- CMOS Schmitt-triggered inputs with pull-down
- Cycle by cycle edge-triggered shutdown logic
- Matched propagation delay for both channels
- Outputs in phase with inputs

Description

The IR2213(S) is a high voltage, high speed power MOSFET and IGBT driver with independent high and low side referenced output channels. Proprietary HVIC and latch immune CMOS technologies enable ruggedized monolithic construction. Logic inputs are compatible with standard CMOS or LSTTL outputs, down to 3.3 V logic. The output drivers feature a high pulse current buffer stage designed for minimum driver cross-conduction. Propagation delays are matched to simplify use in high frequency applications. The floating channel can be used to drive an N-channel power MOSFET or IGBT in the high side configuration which operates up to 1200 V.

Product Summary

V_{OFFSET} (max)	1200 V
$I_{\text{O+/-}}$	1.7 A / 2 A
V_{OUT}	12 V – 20 V
$t_{\text{on/off}}$ (typical)	280 ns / 225 ns
Delay Matching	30 ns

Package Options

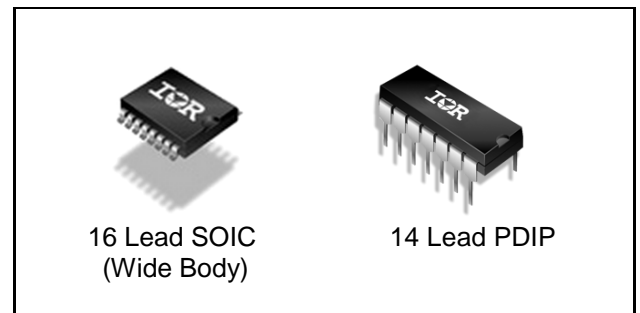

Ordering Information

Base Part Number	Package Type	Standard Pack		Orderable Part Number
		Form	Quantity	
IR2213SPBF	SO16WB	Tube	45	IR2213SPBF
IR2213SPBF	SO16WB	Tape and Reel	1000	IR2213STRPBF
IR2213PBF	PDIP14	Tube	25	IR2213PBF

Typical Connection Diagram

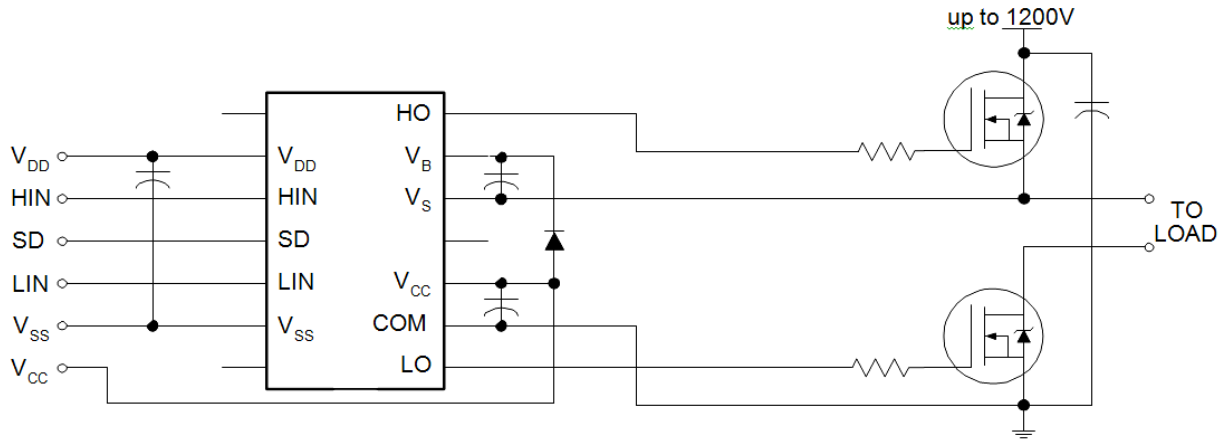

Refer to Lead Assignments for correct pin configuration. This/These diagram(s) show electrical connections only. Please refer to our Application Notes and Design Tips for proper circuit board layout

Absolute Maximum Ratings

Absolute Maximum Ratings indicate sustained limits beyond which damage to the device may occur. All voltage parameters are absolute voltages referenced to COM. The Thermal Resistance and Power Dissipation ratings are measured under board mounted and still air conditions.

Symbol	Definition	Min.	Max.	Units	
V_B	High Side Floating Supply Voltage	-0.3	1225	V	
V_S	High Side Floating Supply Offset Voltage	$V_B - 25$	$V_B + 0.3$		
V_{HO}	High Side Floating Output Voltage	$V_S - 0.3$	$V_B + 0.3$		
V_{CC}	Low Side Fixed Supply Voltage	-0.3	25		
V_{LO}	Low Side Output Voltage	-0.3	$V_{CC} + 0.3$		
V_{DD}	Logic Supply Voltage	-0.3	$V_{SS} + 25$		
V_{SS}	Logic Supply Offset Voltage	$V_{CC} - 25$	$V_{CC} + 0.3$		
V_{IN}	Logic Input Voltage (HIN, LIN & SD)	$V_{SS} - 0.3$	$V_{DD} + 0.3$		
dVs/dt	Allowable Offset Supply Voltage Transient (Figure 2)	—	50	V/ns	
P_D	Package Power Dissipation @ $T_A \leq +25^\circ\text{C}$	(14 Lead PDIP)	—	1.3	W
		(16 Lead SOIC)	—	1.0	
R_{THJA}	Thermal Resistance, Junction to Ambient	(14 Lead PDIP)	—	75	$^\circ\text{C/W}$
		(16 Lead SOIC)	—	100	
T_J	Junction Temperature	—	125	$^\circ\text{C}$	
T_S	Storage Temperature	-55	150		
T_L	Lead Temperature (Soldering, 10 seconds)	—	300		

Recommended Operating Conditions

The Input / Output logic timing diagram is shown in Figure 1. For proper operation the device should be used within the recommended conditions. The V_S and V_{SS} offset ratings are tested with all supplies biased at 15 V differential.

Symbol	Definition	Min.	Max.	Units
V_B	High Side Floating Supply Absolute Voltage	$V_S + 12$	$V_S + 20$	V
V_S	High Side Floating Supply Offset Voltage	†	1200	
V_{HO}	High Side Floating Output Voltage	V_S	V_B	
V_{CC}	Low Side Fixed Supply Voltage	12	20	
V_{LO}	Low Side Output Voltage	0	V_{CC}	
V_{DD}	Logic Supply Voltage	$V_{SS} + 3$	$V_{SS} + 20$	
V_{SS}	Logic Supply Offset Voltage	-5 ^{††}	5	
V_{IN}	Logic Input Voltage (HIN, LIN & SD)	V_{SS}	V_{DD}	

† Logic operational for V_S of -5 to +1200V. Logic state held for V_S of -5V to $-V_{BS}$. (Please refer to the Design Tip DT97-3 for more details).

†† When $V_{DD} < 5V$, the minimum V_{SS} offset is limited to $-V_{DD}$

Dynamic Electrical Characteristics

V_{BIAS} (V_{CC} , V_{BS} , V_{DD}) = 15 V, C_L = 1000 pF, T_A = 25 °C and V_{SS} = COM unless otherwise specified. The dynamic electrical characteristics are measured using the test circuit shown in Figure 3.

Symbol	Definition	Min.	Typ.	Max.	Units	Test Conditions
t_{on}	Turn-On Propagation Delay	—	280	—	ns	$V_S = 0V$
t_{off}	Turn-Off Propagation Delay	—	225	—		$V_S = 1200V$
t_{sd}	Shutdown Propagation Delay	—	230	—		$V_S = 1200V$
t_r	Turn-On Rise Time	—	25	—		
t_f	Turn-Off Fall Time	—	17	—		
MT	Delay Matching, HS & LS Turn-On/Off	—	—	30		

Static Electrical Characteristics

V_{BIAS} (V_{CC} , V_{BS} , V_{DD}) = 15 V, T_A = 25 °C and V_{SS} = COM unless otherwise specified. The V_{IN} , V_{TH} and I_{IN} parameters are referenced to V_{SS} and are applicable to all three logic input leads: HIN, LIN and SD. The V_O and I_O parameters are referenced to COM and are applicable to the respective output leads: HO or LO.

Symbol	Definition	Min.	Typ.	Max.	Units	Test Conditions
V_{IH}	Logic "1" Input Voltage	9.5	—	—	V	
V_{IL}	Logic "0" Input Voltage	—	—	6.0		
V_{OH}	High Level Output Voltage, $V_{BIAS} - V_O$	—	—	1.2		$I_O = 0A$
V_{OL}	Low Level Output Voltage, V_O	—	—	0.1		$I_O = 0A$
I_{LK}	Offset Supply Leakage Current	—	—	50	μA	$V_B = V_S = 1200V$
I_{QBS}	Quiescent V_{BS} Supply Current	—	125	230		$V_{IN} = 0V$ or V_{DD}
I_{QCC}	Quiescent V_{CC} Supply Current	—	180	340		$V_{IN} = 0V$ or V_{DD}
I_{QDD}	Quiescent V_{DD} Supply Current	—	15	30		$V_{IN} = 0V$ or V_{DD}
I_{IN+}	Logic "1" Input Bias Current	—	20	40		$V_{IN} = V_{DD}$
I_{IN-}	Logic "0" Input Bias Current	—	—	1.0	$V_{IN} = 0V$	
V_{BSUV+}	V_{BS} Supply Undervoltage Positive Going Threshold	8.7	10.2	11.7	V	
V_{BSUV-}	V_{BS} Supply Undervoltage Negative Going Threshold	7.9	9.3	10.7		
V_{CCUV+}	V_{CC} Supply Undervoltage Positive Going Threshold	8.7	10.2	11.7		
V_{CCUV-}	V_{CC} Supply Undervoltage Negative Going Threshold	7.9	9.3	10.7		
I_{O+}	Output High Short Circuit Pulsed Current	1.7	2.0	—	A	$V_O = 0V, V_{IN} = V_{DD}$ $PW \leq 10 \mu s$
I_{O-}	Output Low Short Circuit Pulsed Current	2.0	2.5	—		$V_O = 15V, V_{IN} = 0V$ $PW \leq 10 \mu s$

Functional Block Diagram

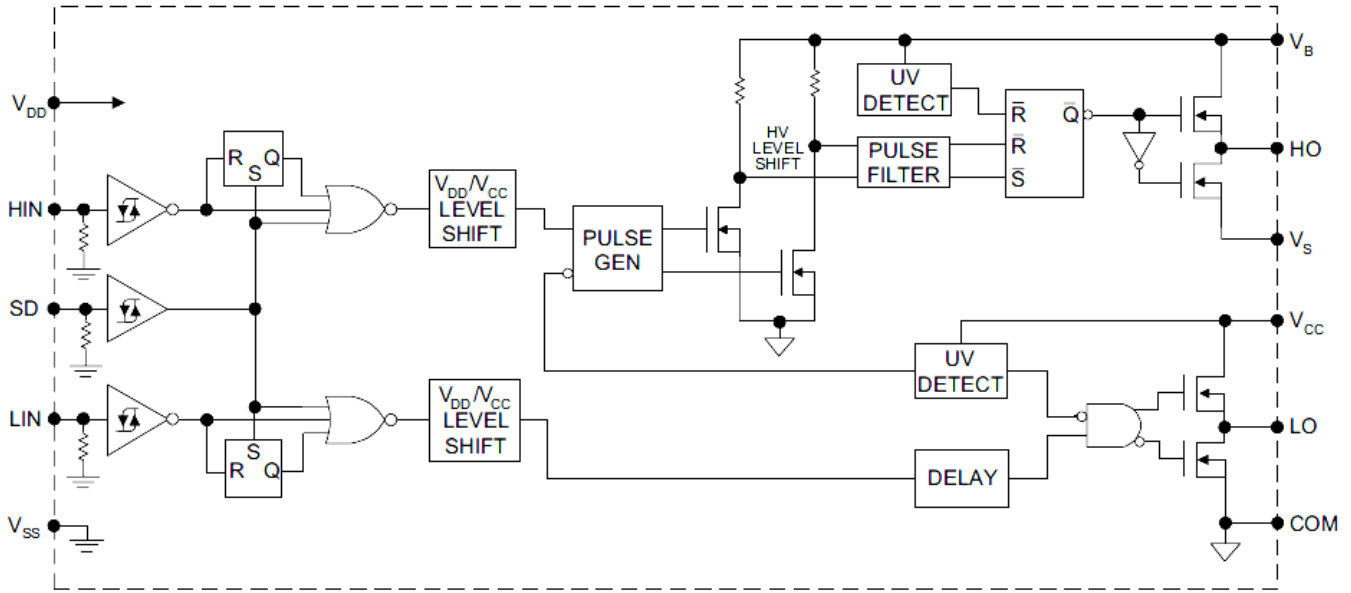

Lead Definitions

Symbol	Description
V _{DD}	Logic Supply
HIN	Logic Input for High Side Gate Driver Output (HO), In Phase
SD	Logic Input for Shutdown
LIN	Logic Input for Low Side Gate Driver Output (LO), In Phase
V _{SS}	Logic Ground
V _B	High Side Floating Supply
HO	High Side Gate Drive Output
V _S	High Side Floating Supply Return
V _{CC}	Low Side Supply
LO	Low Side Gate Drive Output
COM	Low Side Return

Lead Assignments

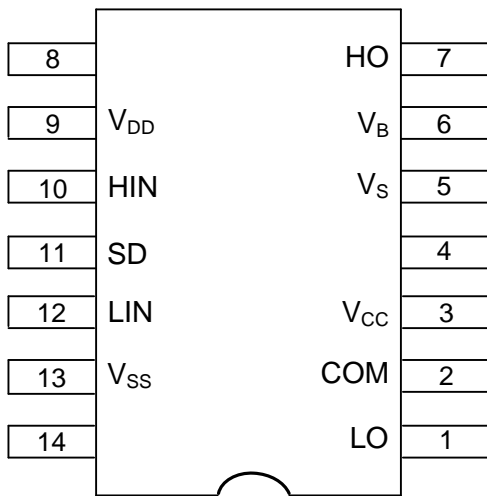

14-Lead PDIP

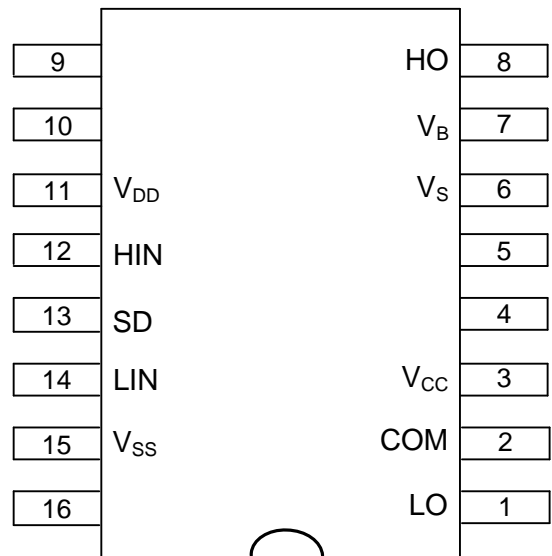

16-Lead SOIC
(Wide Body)

Application Information and Additional Information

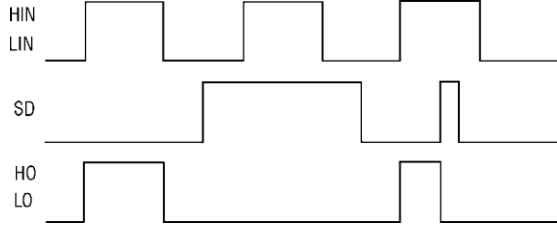

Figure 1. Input / Output Timing Diagram

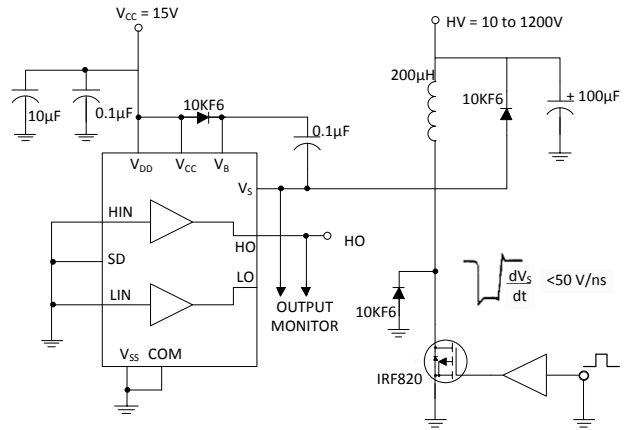

Figure 2. Floating Supply Voltage Transient Test Circuit

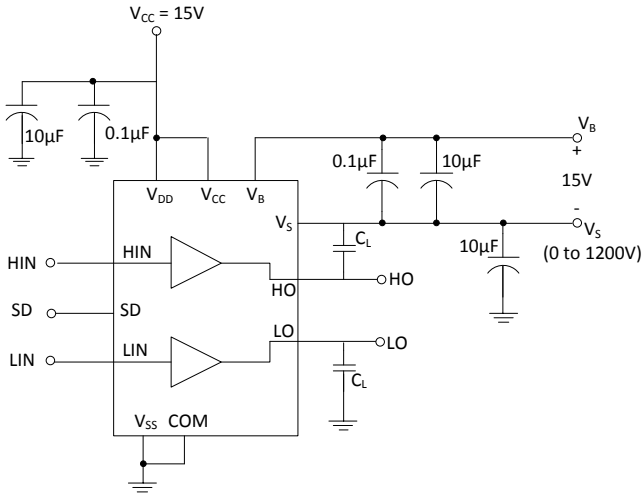

Figure 3. Switching Time Test Circuit

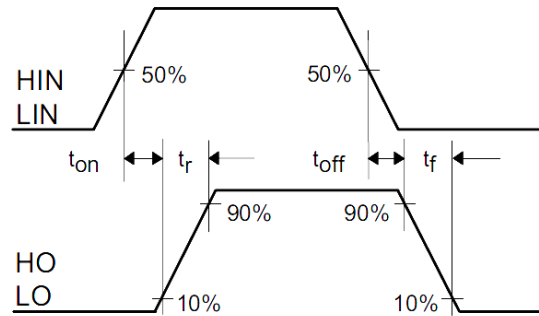

Figure 4. Switching Time Waveform Definition

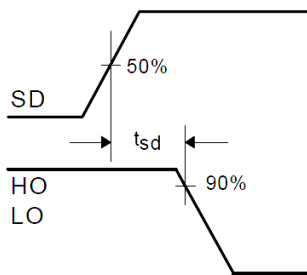

Figure 5. Shutdown Waveform Definitions

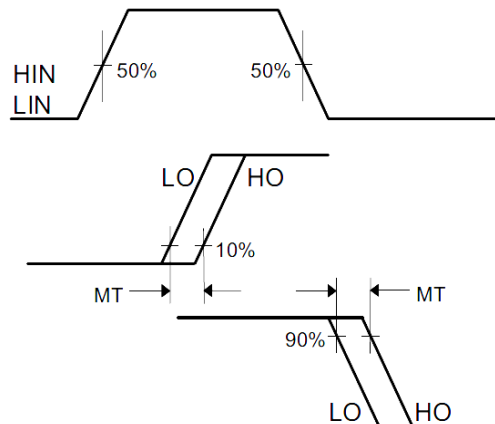

Figure 6. Delay Matching Waveform Definitions

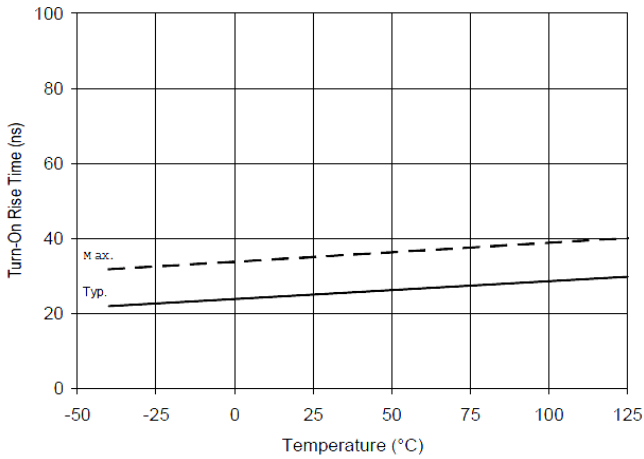

Figure 7A. Turn-On Rise Time vs. Temperature

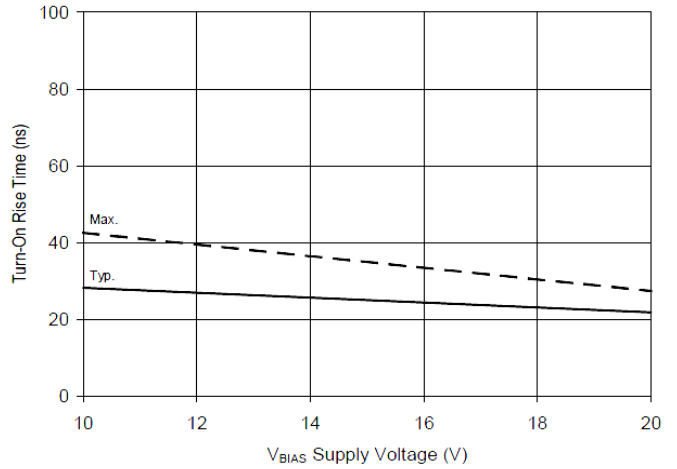

Figure 7B. Turn-On Rise Time vs. Voltage

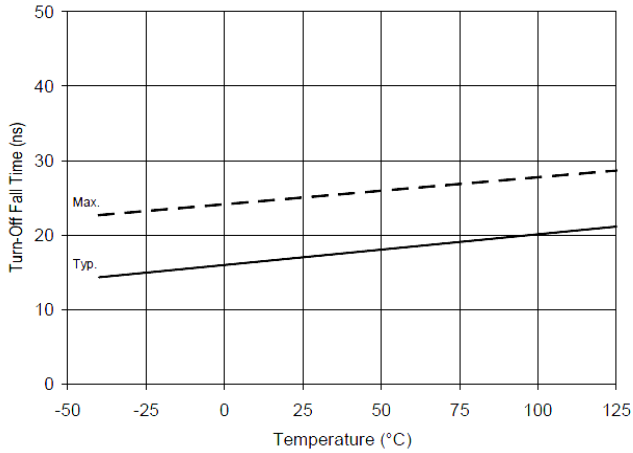

Figure 8A. Turn-Off Fall Time vs. Temperature

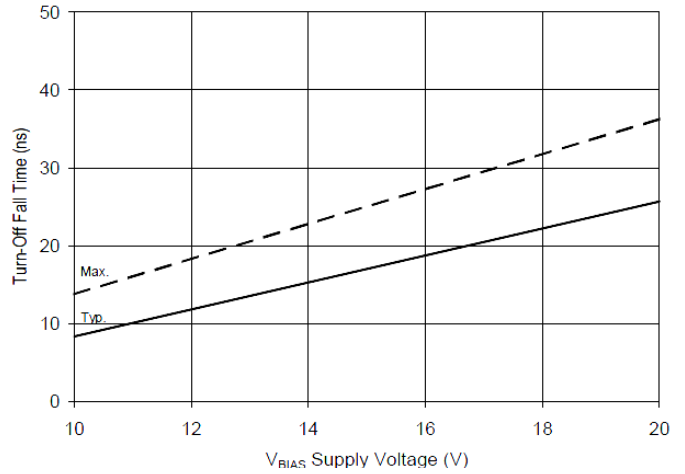

Figure 8B. Turn-Off Fall Time vs. Voltage

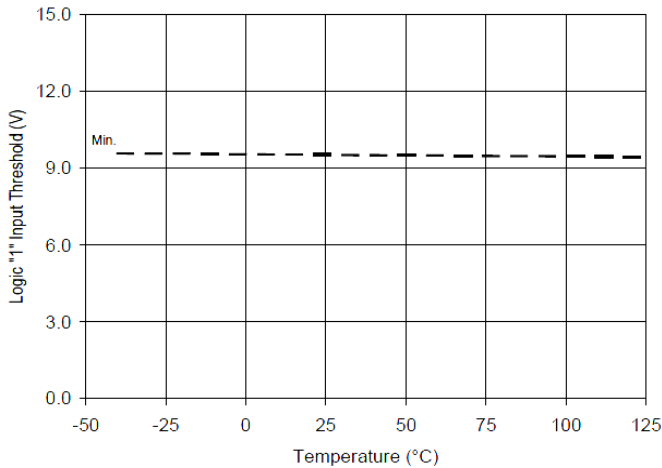

Figure 9A. Logic "1" Input Threshold vs. Temperature

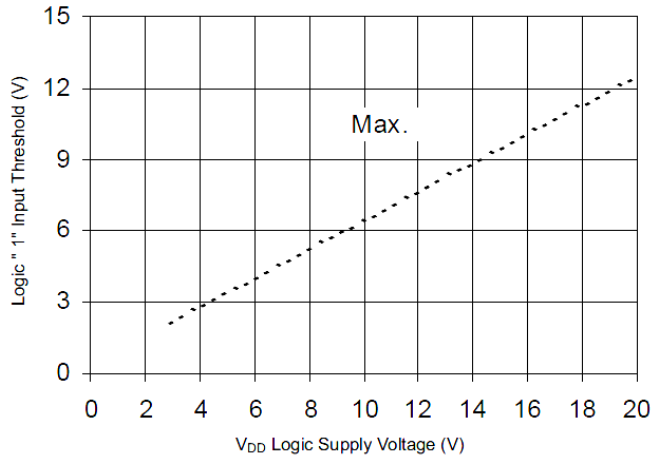

Figure 9B. Logic "1" Input Threshold vs. Voltage

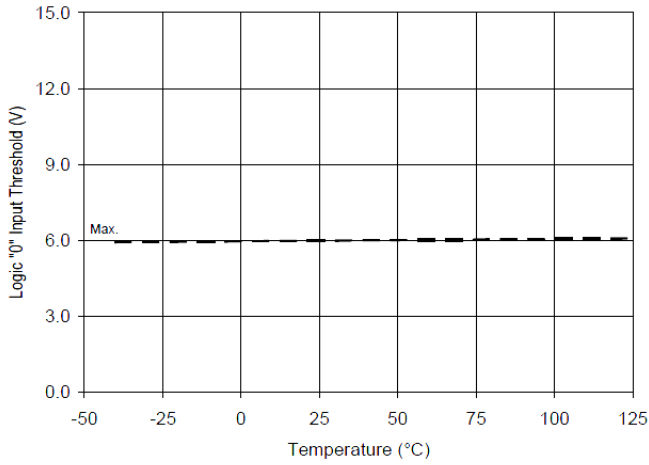

Figure 10A. Logic "0" Input Threshold vs. Temperature

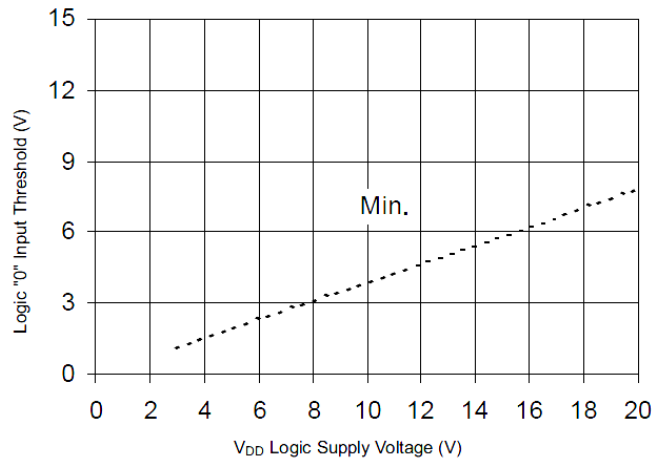

Figure 10B. Logic "0" Input Threshold vs. Voltage

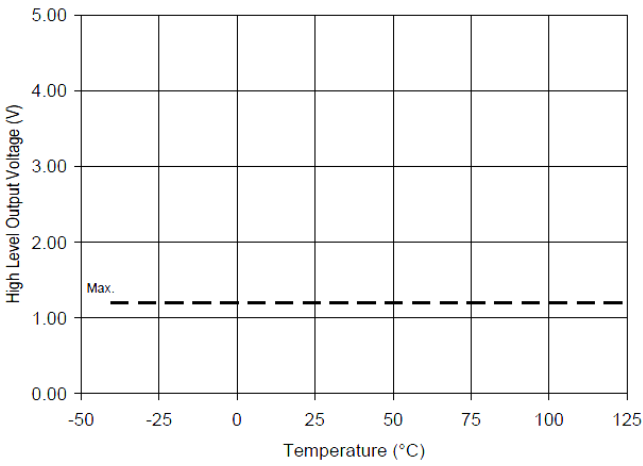

Figure 11A. High Level Output vs. Temperature

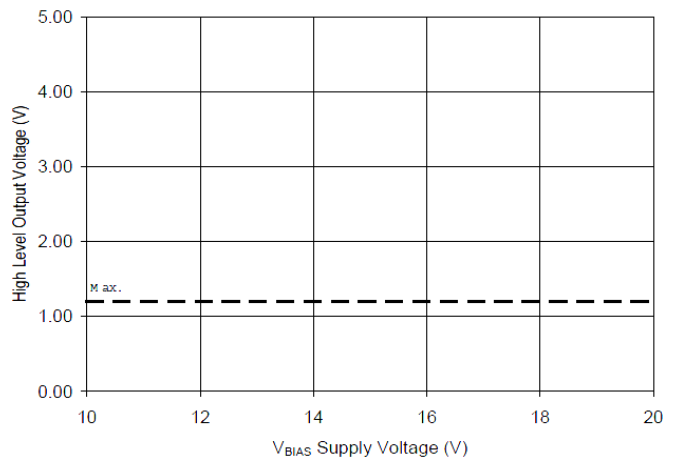

Figure 11B. High Level Outputs vs. Voltage

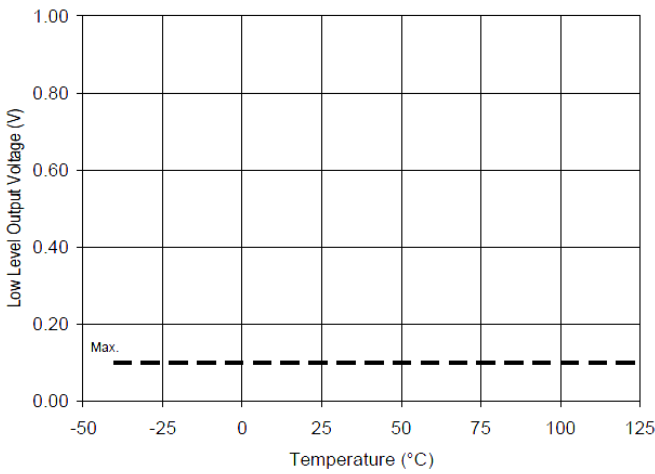

Figure 12A. Low Level Output vs. Temperature

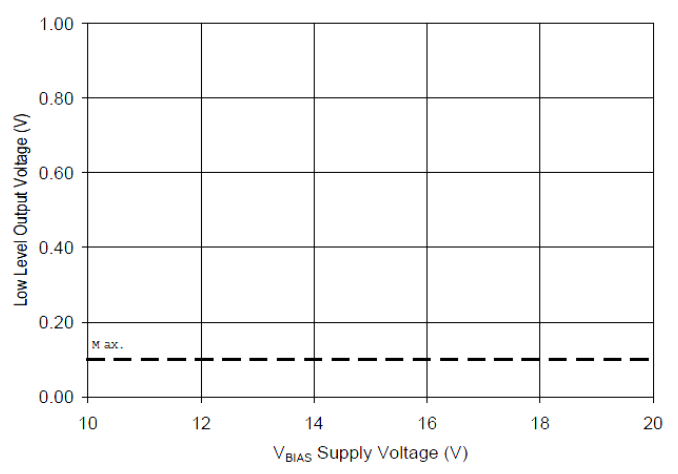

Figure 12B. Low Level Output vs. Voltage

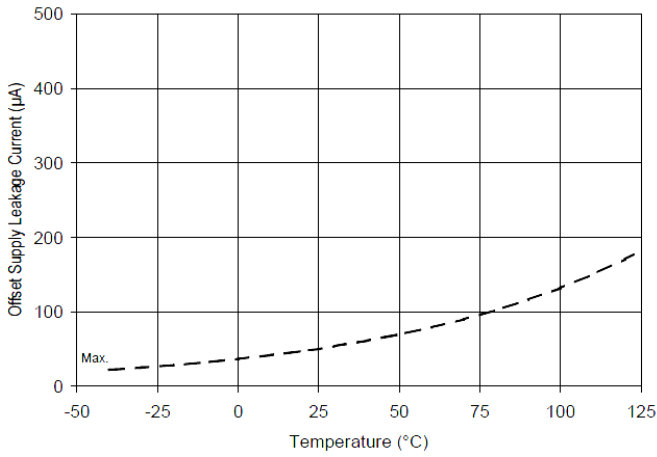

Figure 13A. Offset Supply Current vs. Temperature

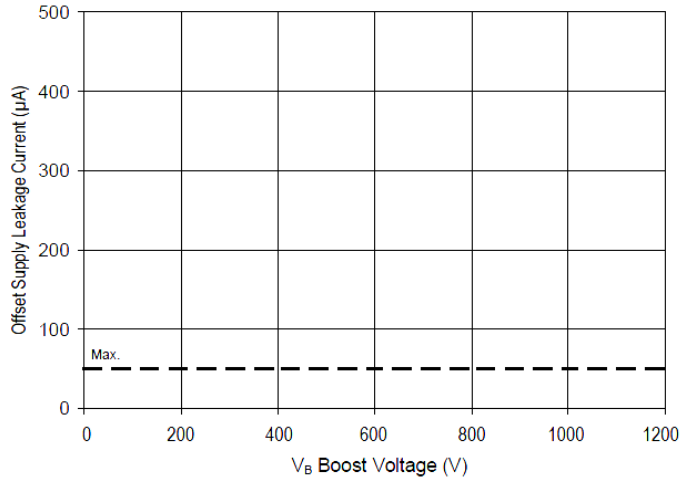

Figure 13B. Offset Supply Current vs. Voltage

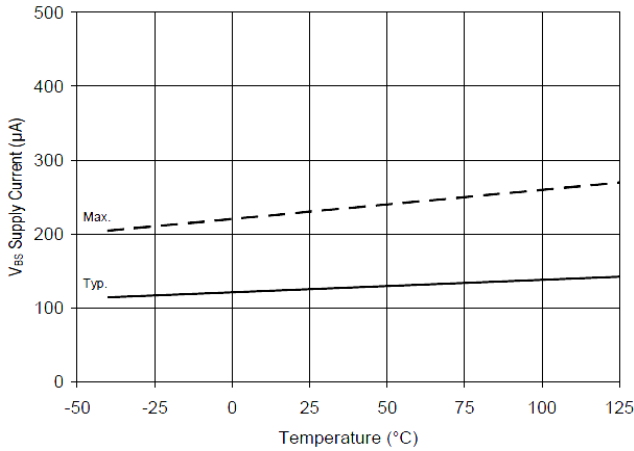

Figure 14A. V_{BS} Supply Current vs. Temperature

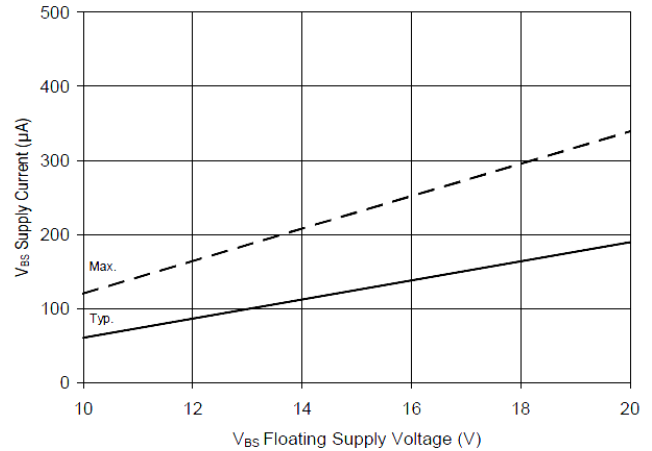

Figure 14B. V_{BS} Supply Current vs. Voltage

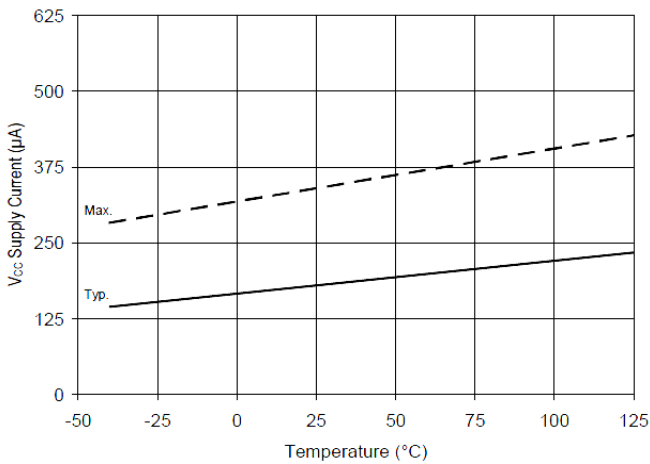

Figure 15A. V_{CC} Supply Current vs. Temperature

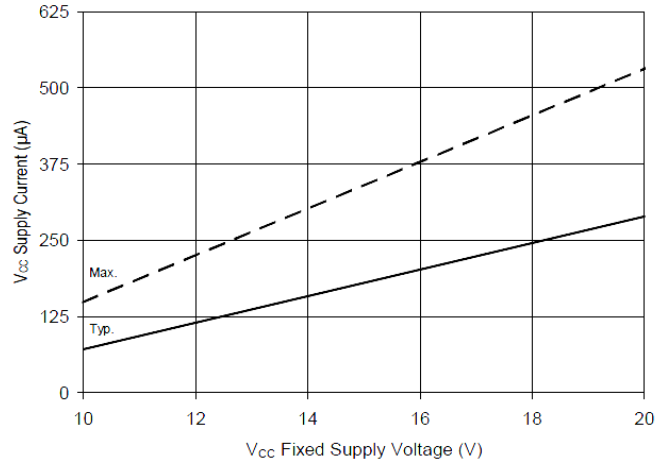

Figure 15B. V_{CC} Supply Current vs. Voltage

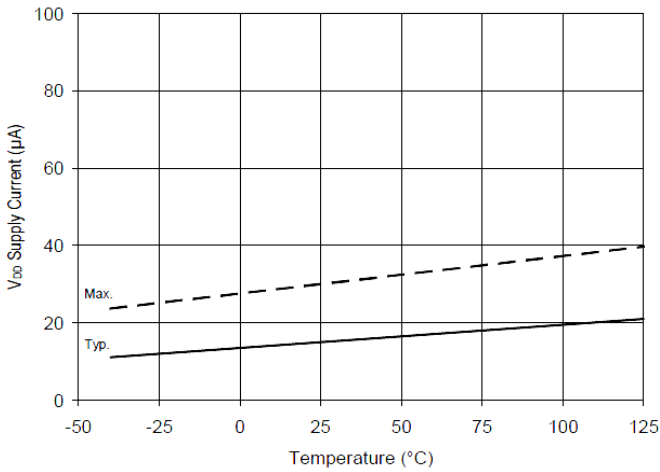

Figure 16A. V_{DD} Supply Current vs. Temperature

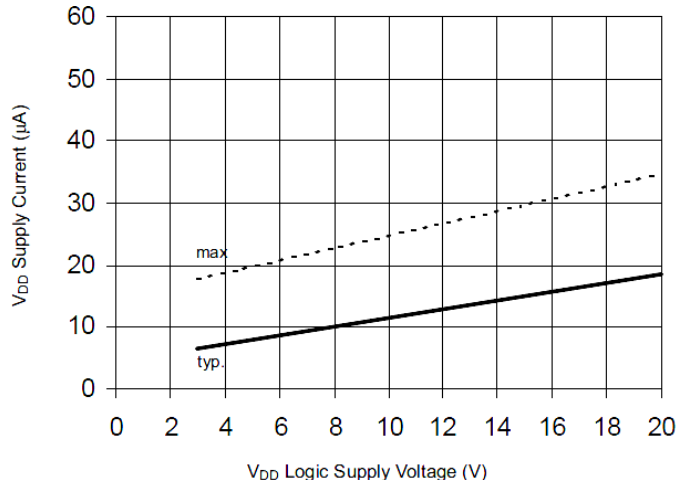

Figure 16B. V_{DD} Supply Current vs. V_{DD} Voltage

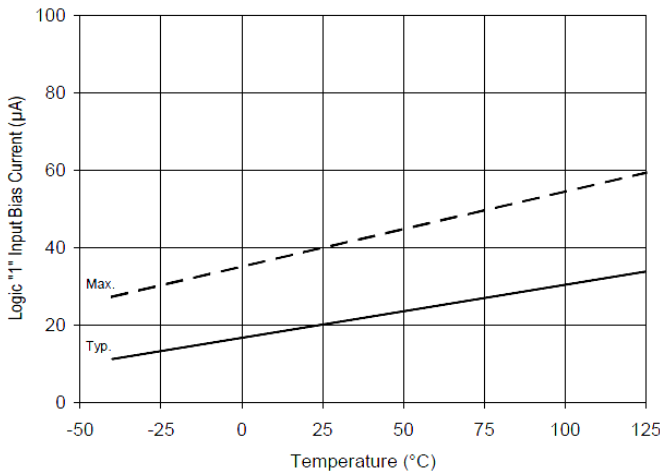

Figure 17A. Logic "1" Input Current vs. Temperature

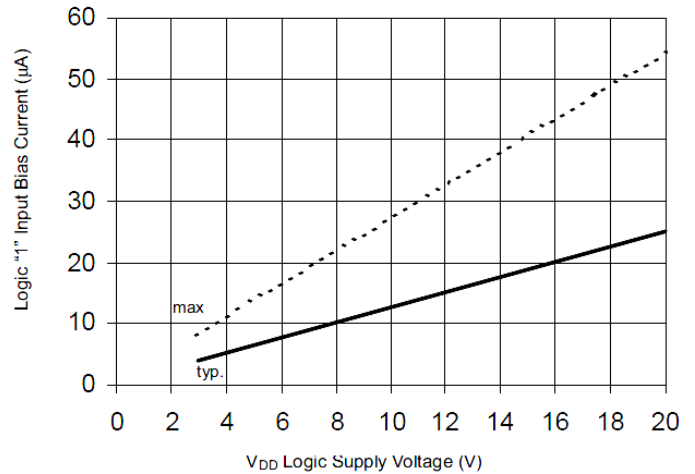

Figure 17B. Logic "1" Input Current vs. V_{DD} Voltage

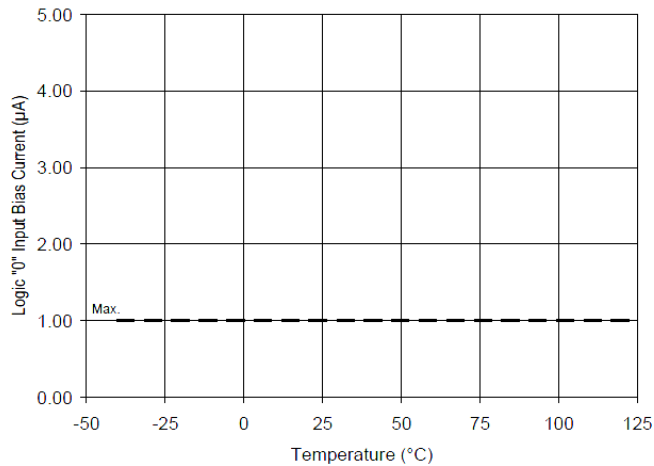

Figure 18A. Logic "0" Input Current vs. Temperature

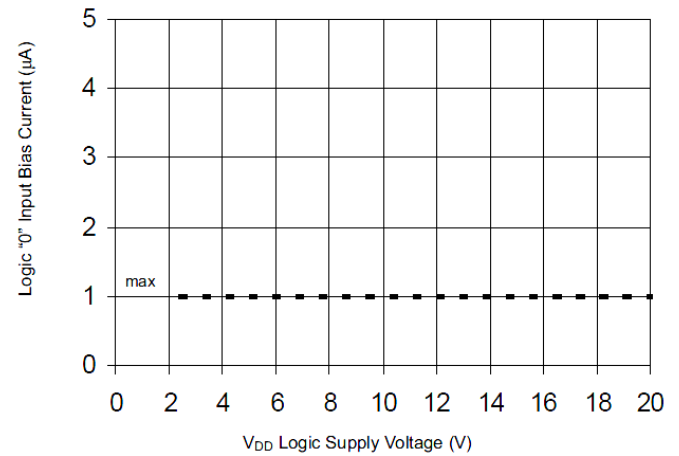

Figure 18B. Logic "0" Input Current vs. V_{DD} Voltage

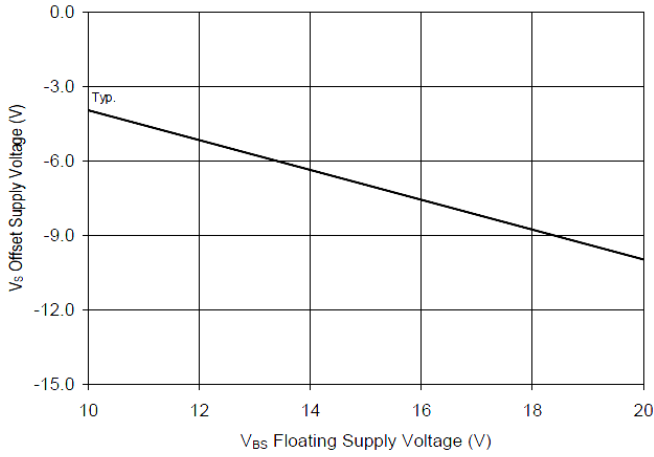

Figure 19. Maximum V_S Negative Offset vs. V_{BS} Supply Voltage

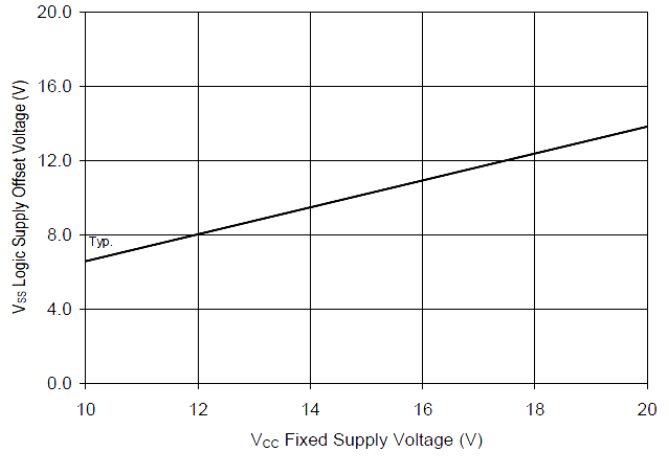
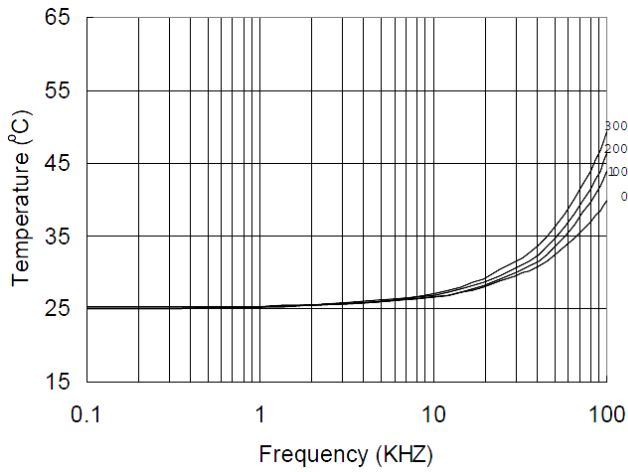
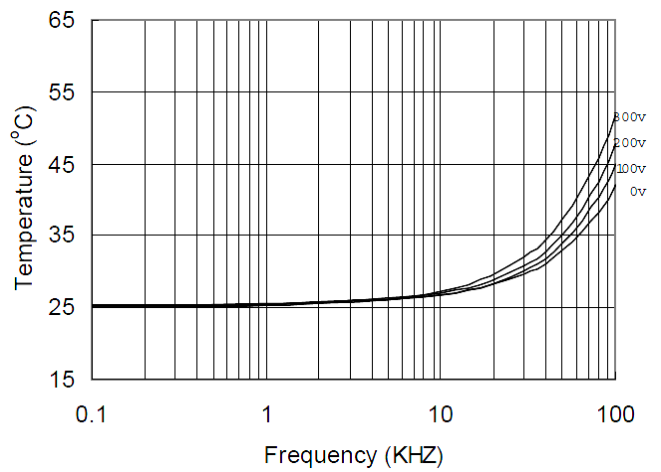

Figure 20. Maximum V_{SS} Positive Offset vs. V_{CC} Supply Voltage



**Figure 21. IR2213S vs. Frequency (IRFBC20)
 $R_{gate}=33\Omega$, $V_{CC}=15V$**



**Figure 22. IR2213S vs. Frequency (IRFBC30)
 $R_{gate}=22\Omega$, $V_{CC}=15V$**

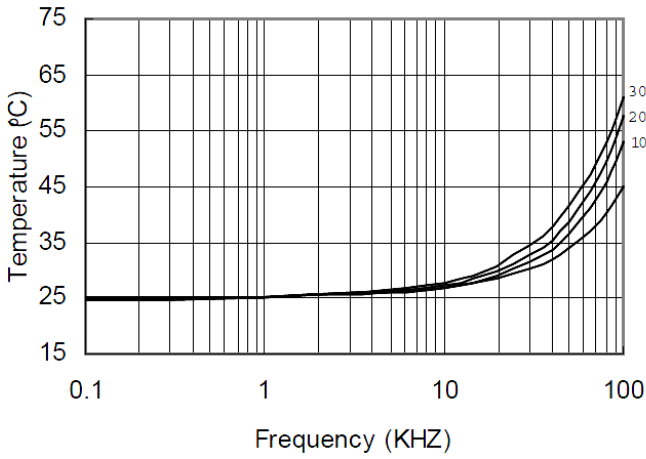

Figure 23. IR2213S vs. Frequency (IRFBC40)
 $R_{gate}=15\Omega, V_{CC}=15V$

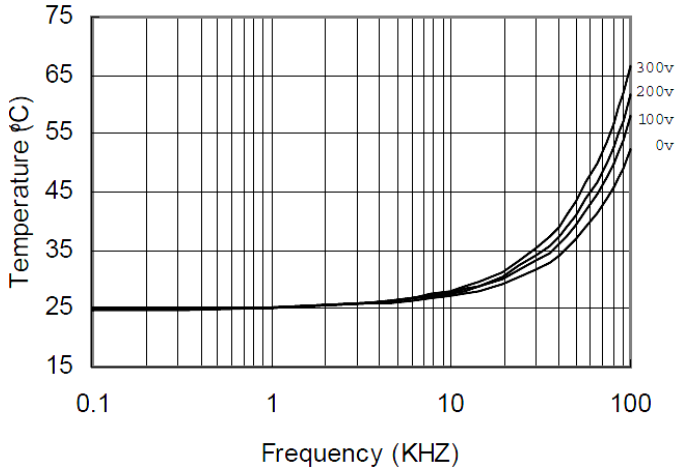

Figure 24. IR2213S vs. Frequency (IRFBC50)
 $R_{gate}=10\Omega, V_{CC}=15V$

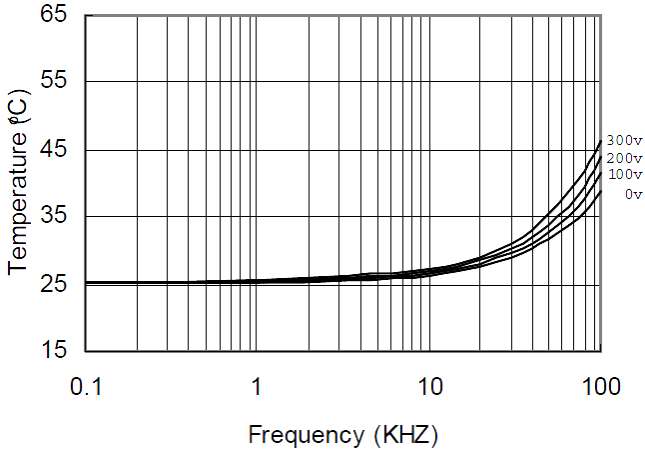

Figure 25. IR2213 vs. Frequency (IRFBC20)
 $R_{gate}=33\Omega, V_{CC}=15V$

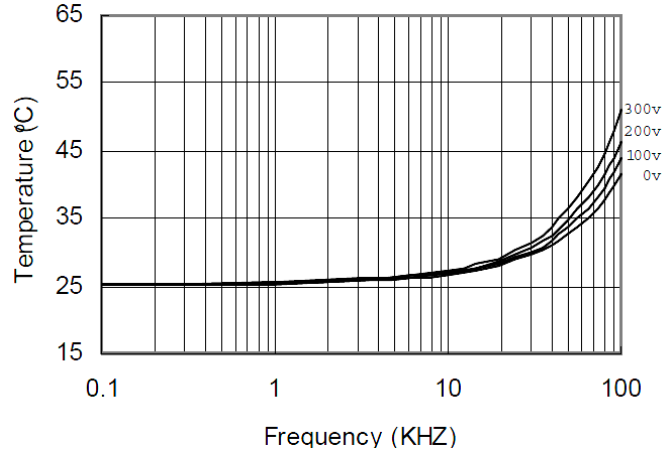

Figure 26. IR2213 vs. Frequency (IRFBC30)
 $R_{gate}=22\Omega, V_{CC}=15V$

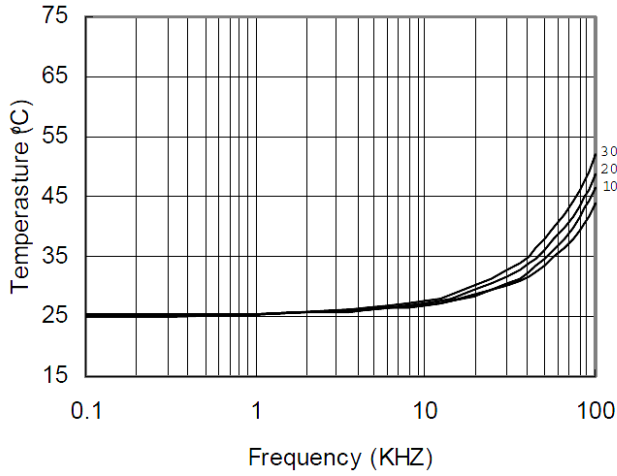

Figure 27. IR2213 vs. Frequency (IRFBC40)
 $R_{gate}=15\Omega, V_{CC}=15V$

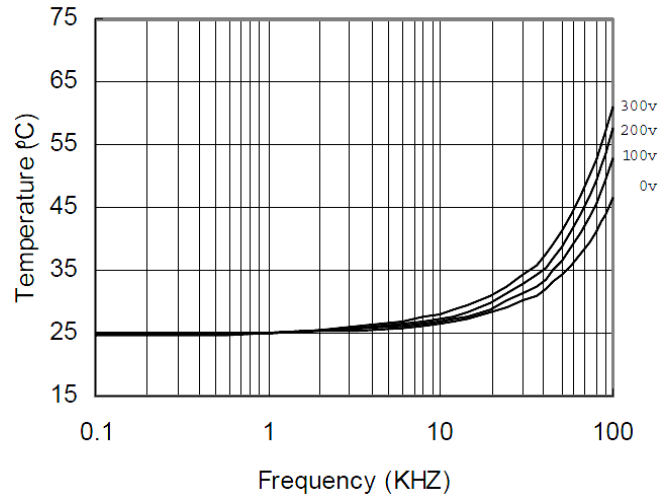
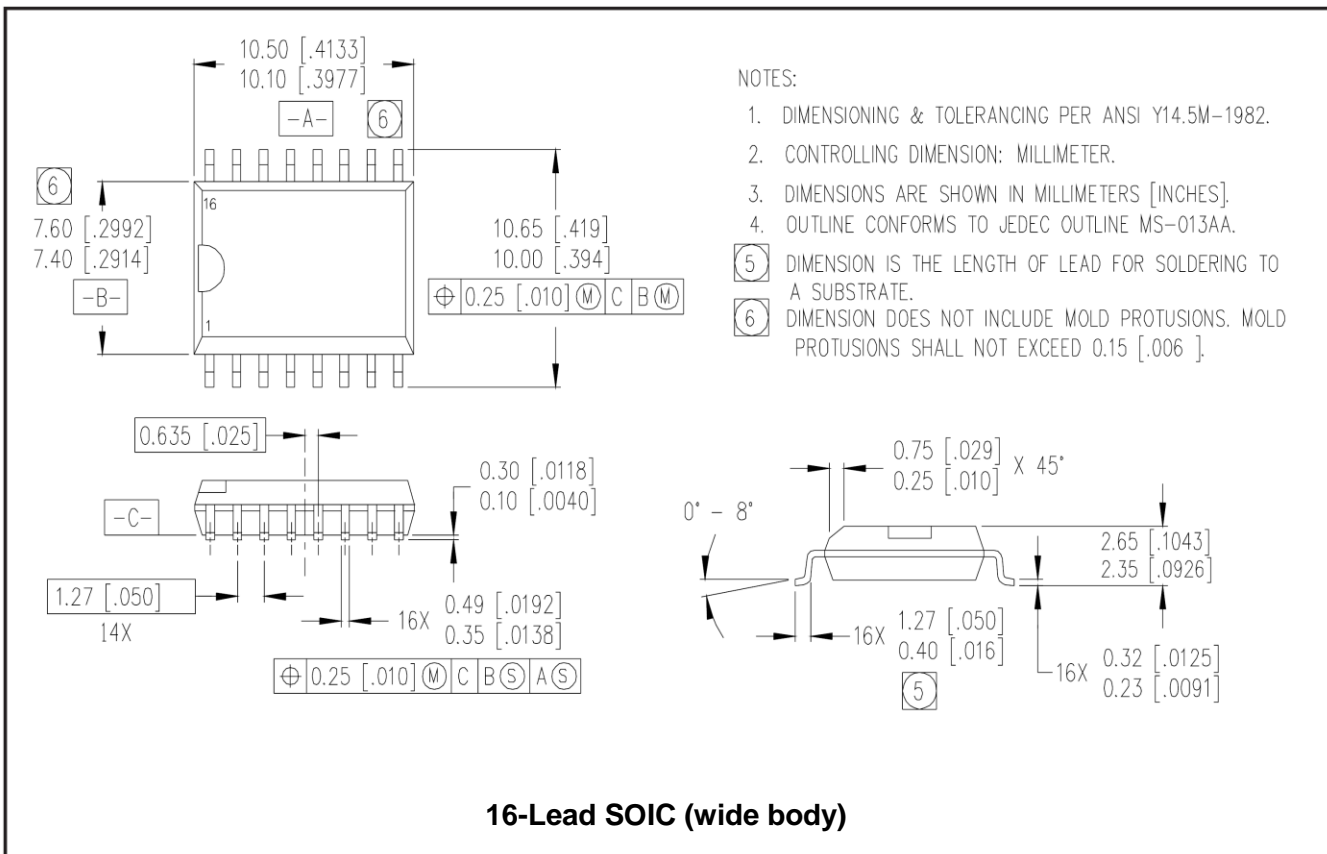
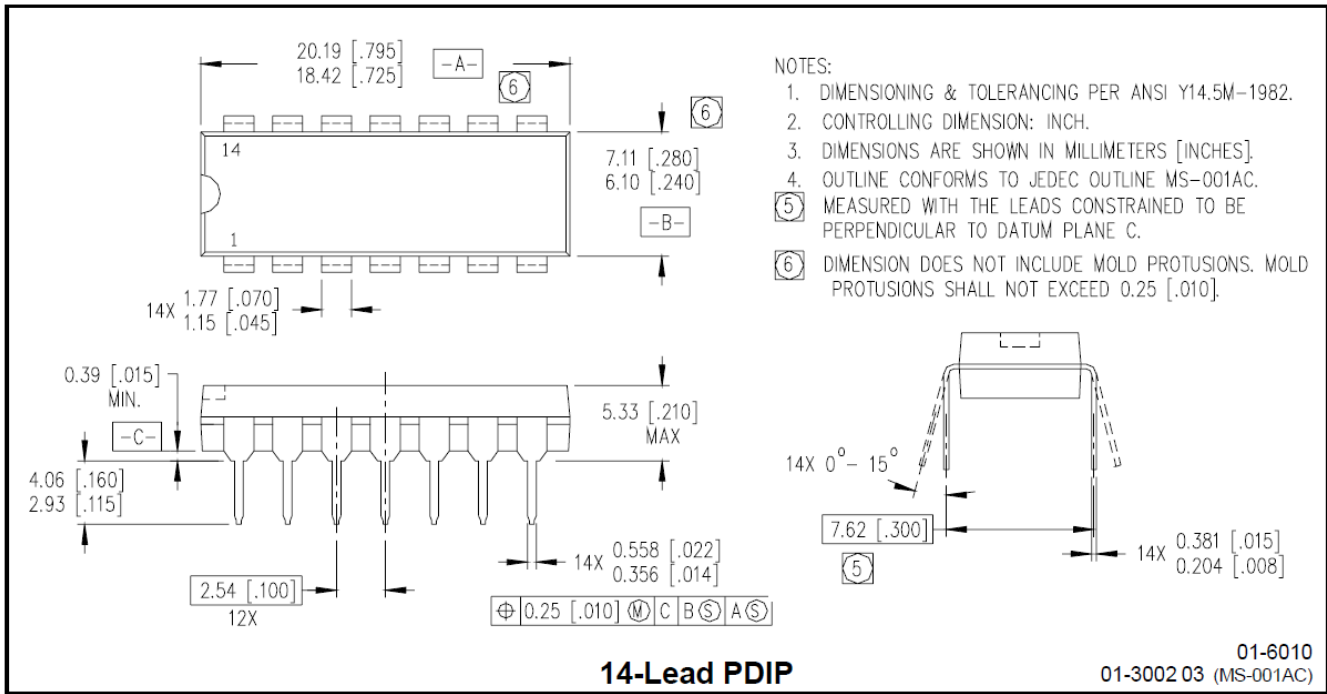
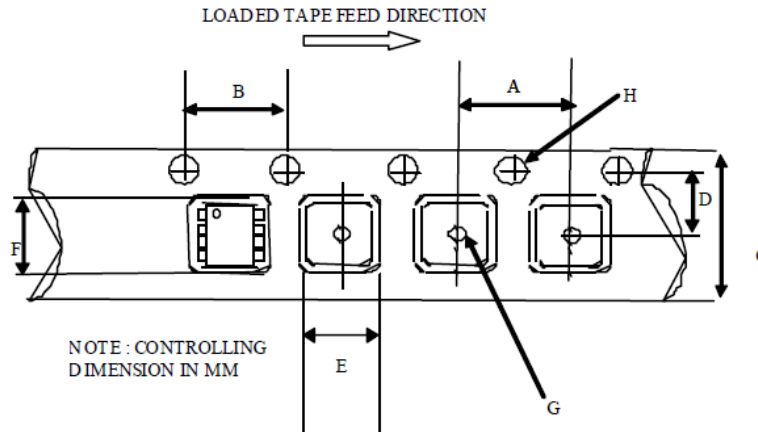
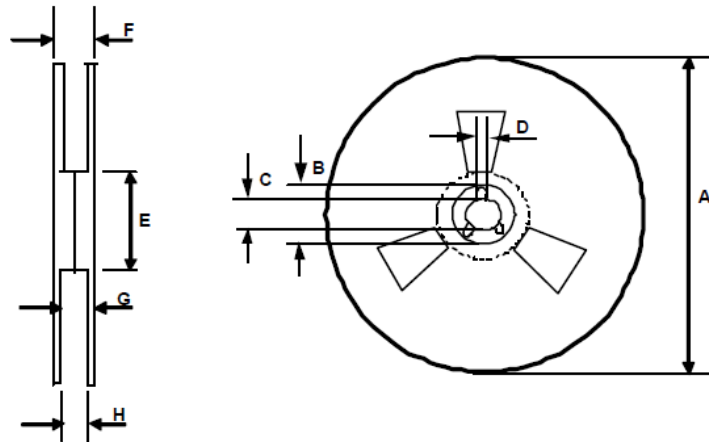

Figure 28. IR2213 vs. Frequency (IRFBC50)
 $R_{gate}=10\Omega, V_{CC}=15V$

Package Details

Tape and Reel Details, SO16WB

CARRIER TAPE DIMENSION FOR 16SOICW

Code	Metric		Imperial	
	Min	Max	Min	Max
A	11.90	12.10	0.468	0.476
B	3.90	4.10	0.153	0.161
C	15.70	16.30	0.618	0.641
D	7.40	7.60	0.291	0.299
E	10.80	11.00	0.425	0.433
F	10.60	10.80	0.417	0.425
G	1.50	n/a	0.059	n/a
H	1.50	1.60	0.059	0.062

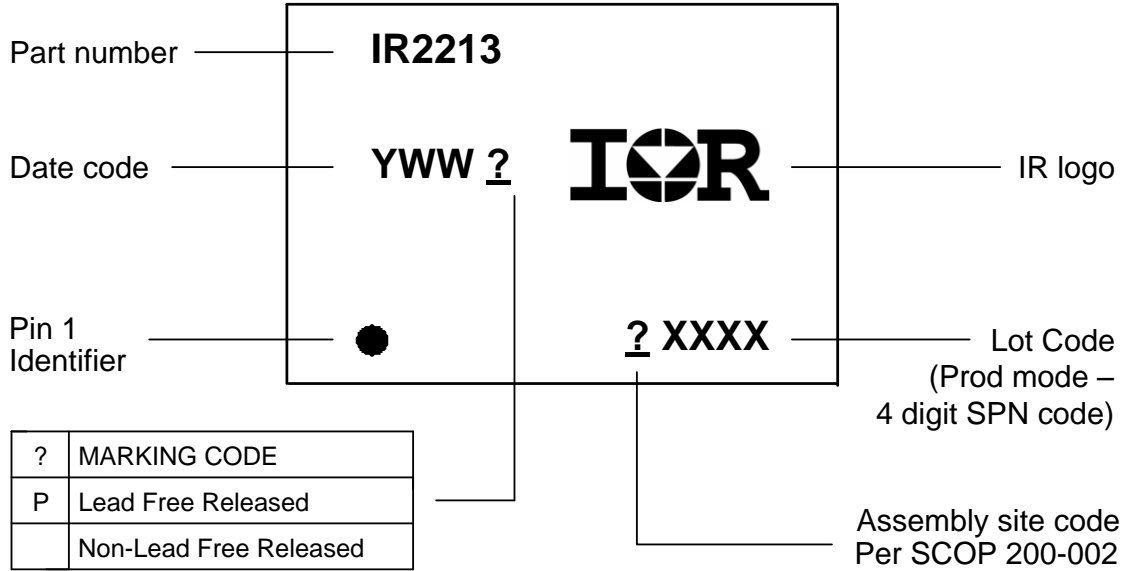

REEL DIMENSIONS FOR 16SOICW

Code	Metric		Imperial	
	Min	Max	Min	Max
A	329.60	330.25	12.976	13.001
B	20.95	21.45	0.824	0.844
C	12.80	13.20	0.503	0.519
D	1.95	2.45	0.767	0.096
E	98.00	102.00	3.858	4.015
F	n/a	22.40	n/a	0.881
G	18.50	21.10	0.728	0.830
H	16.40	18.40	0.645	0.724

Part Marking Information

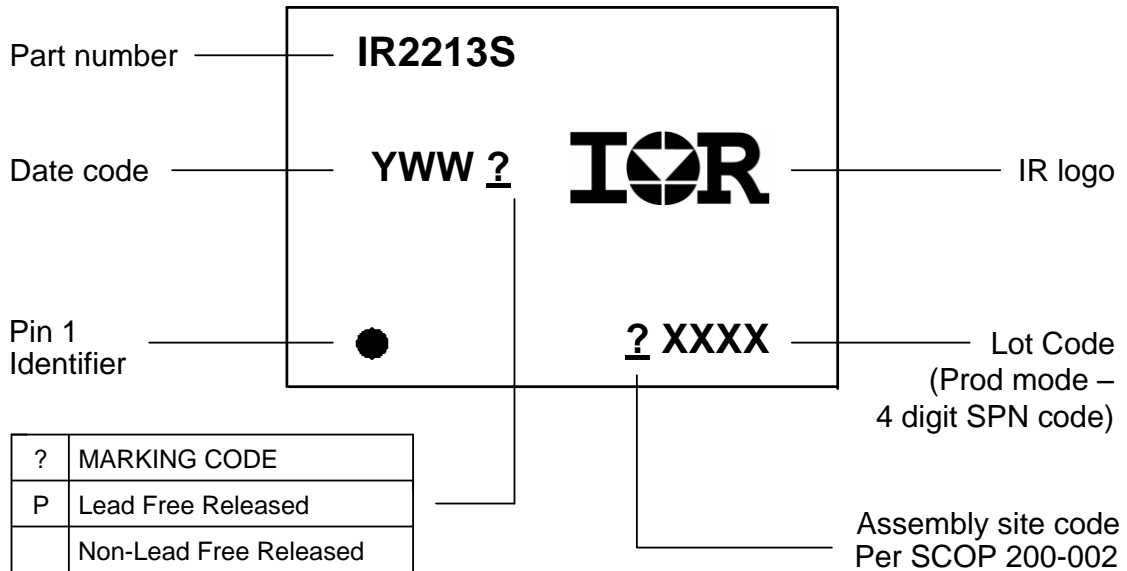

14-Lead PDIP



16-Lead SOIC (wide body)

Qualification Information[†]

Qualification Level	Industrial ^{††} (per JEDEC JESD 47)	
	Comments: This family of ICs has passed JEDEC's Industrial qualification. IR's Consumer qualification level is granted by extension of the higher Industrial level.	
Moisture Sensitivity Level	SOIC16WB	MSL3 ^{†††} (per IPC/JEDEC J-STD 020)
	PDIP14	Not applicable (non-surface mount package style)
RoHS Compliant	Yes	

- † Qualification standards can be found at International Rectifier's web site <http://www.irf.com/>
- †† Higher qualification ratings may be available should the user have such requirements. Please contact your International Rectifier sales representative for further information.
- ††† Higher MSL ratings may be available for the specific package types listed here. Please contact your International Rectifier sales representative for further information.

The information provided in this document is believed to be accurate and reliable. However, International Rectifier assumes no responsibility for the consequences of the use of this information. International Rectifier assumes no responsibility for any infringement of patents or of other rights of third parties which may result from the use of this information. No license is granted by implication or otherwise under any patent or patent rights of International Rectifier. The specifications mentioned in this document are subject to change without notice. This document supersedes and replaces all information previously supplied.

For technical support, please contact IR's Technical Assistance Center
<http://www.irf.com/technical-info/>

WORLD HEADQUARTERS:
 233 Kansas St., El Segundo, California 90245
 Tel: (310) 252-7105